

Overview

HPE ProLiant DL345 Gen10 Plus server

The HPE ProLiant DL345 Gen10 Plus server is redefining price/performance with the new math for virtualized compute. Powered by the latest AMD® EPYC® 7003 Series Processors, the HPE ProLiant DL345 Gen10 Plus server offers greater processing power, faster memory speeds up to 3200 MT/s. and increased data transfer rates with PCIe Gen4 capabilities.

This 1P, 2U server has been designed with flexibility while delivering a high core count and large memory footprint. Choose this purpose-built platform for virtualization, High Performance Compute and memory centric workloads.

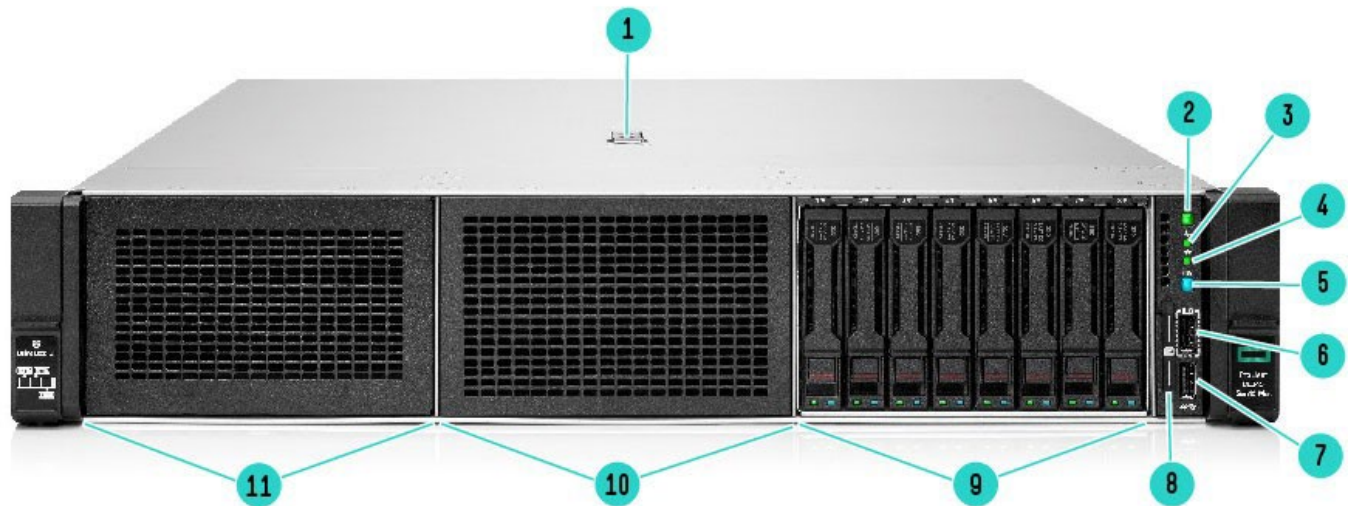

HPE ProLiant DL345 Gen10 Plus 8 SFF Server- Front View

- | | |
|--|---|
| 1. Quick removal access panel | 7. USB 3.1 Gen1 |
| 2. Power On/Standby button and system power LED button | 8. Serial label pull tag |
| 3. Health LED | 9. Drive Bay 3. 8SFF SAS/SATA shown (Box 3) |
| 4. NIC status | 10. Drive Bay 2. Blank shown(Box 2) |
| 5. Unit ID button | 11. Drive Bay 1. Blank shown (Box 1) |
| 6. iLO front service port | |

Notes:

- 8 SFF SAS/SATA or 8 SFF U.2/U.3 optional
- 8 SFF SAS/SATA or 8 SFF U.2/U.3 optional
- 8 SFF SAS/SATA or 8 SFF U.2/U.3 optional

Overview

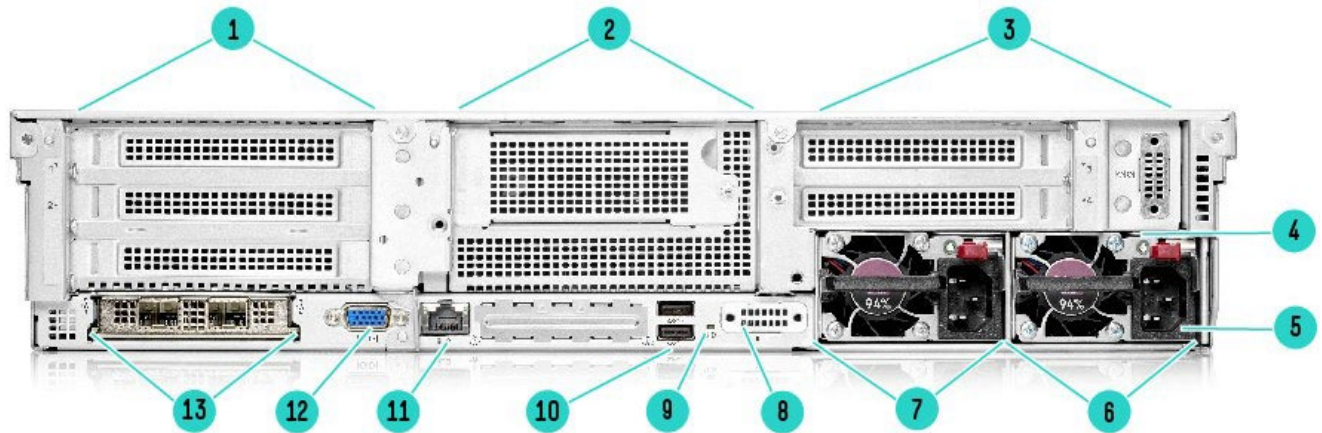

HPE ProLiant DL345 Gen10 Plus server - Rear View

- | | | | |
|----|---|-----|----------------------------------|
| 1. | Primary Riser. ¹ | 8. | Optional serial port (not shown) |
| 2. | Rear Drive Cage (2SFF SAS/SATA/NVMe optional) | 9. | UID LED |
| 3. | Secondary Riser. ² | 10. | USB connectors 3.1 Gen1 (2) |
| 4. | Power supply power LED | 11. | Dedicated iLO management port |
| 5. | Power supply power connection | 12. | VGA Connector |
| 6. | HPE Flexible Slot Power Supply bay 1 | 13. | OCP 3.0 Slot |
| 7. | HPE Flexible Slot Power Supply bay 2 | | |

Notes:

- ¹ PCIe Slots 1-2 top to bottom, riser shipped standard, not shown.
- ² PCIe Slots 3-4 top to bottom, not shown.



Overview

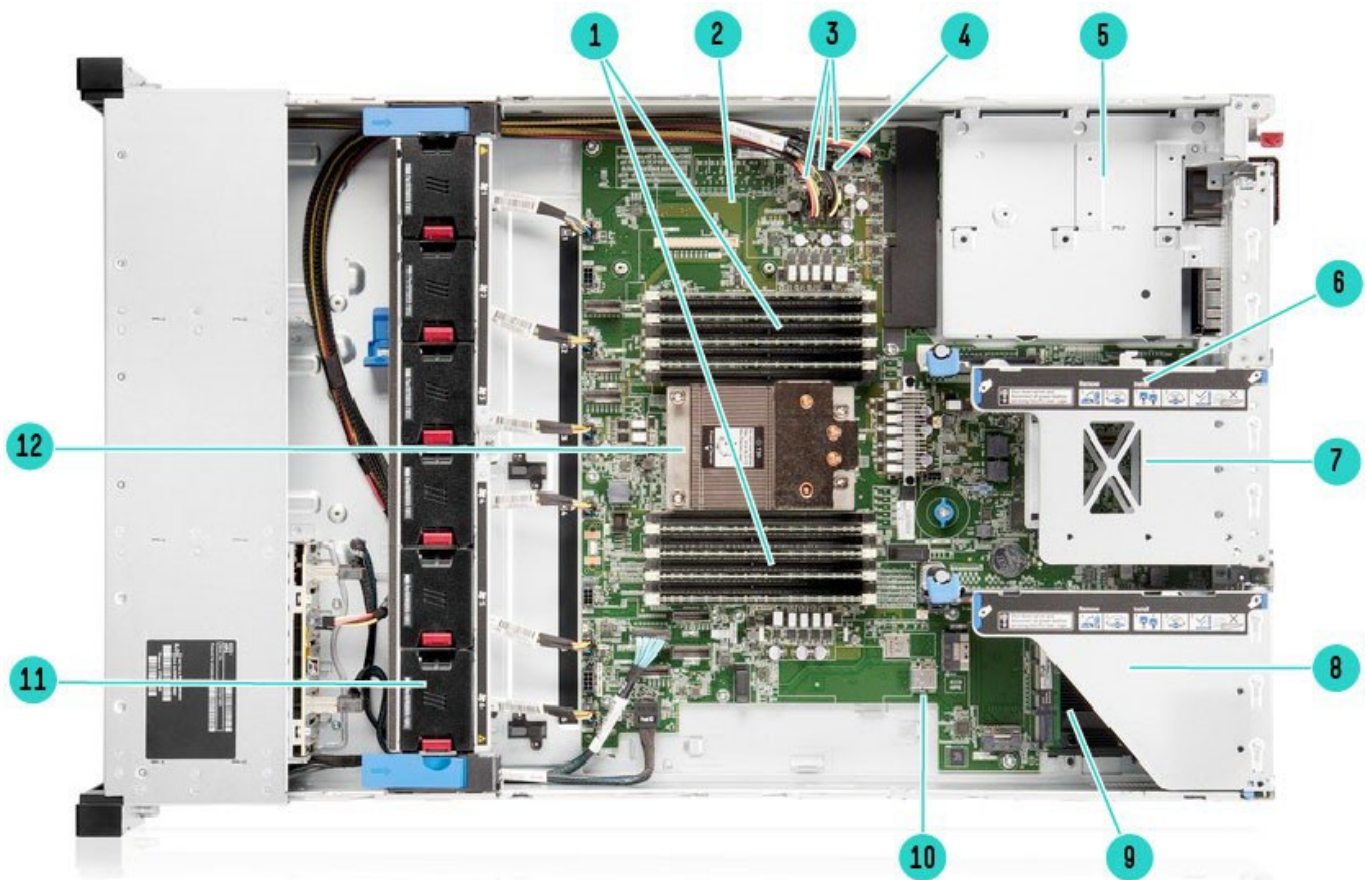

HPE ProLiant DL345 Gen10 Plus server - Internal View

8SFF chassis

- | | | | |
|---|--|----|---|
| 1 | DDR4 DIMM slots | 7 | (Under) Serial Port Connector |
| 2 | Optional HPE Flexible Smart Array Controller (Not shown) | 8 | Primary PCIe riser, standard |
| 3 | Hard drive backplane power connectors | 9 | (Under) OCP 3.0 Slot |
| 4 | Chassis intrusion detection connector | 10 | Internal USB 3.1 Gen1 connector |
| 5 | Hot Plug redundant HPE Flexible Slot Power supplies | 11 | Fan cage shown with 6 Performance Hot-plug fans |
| 6 | Connection for (optional) secondary riser | 12 | Processor (heatsink shown) |

What's New:

- Supports the latest AMD EPYC 7003 Series processor
- Support for Tri-mode storage controllers for SAS/SATA/NVMe drives
- New Basic Carrier SAS/SATA/NVMe drives.
- European Union (EU) Lot 9 regulation, please visit: <https://www.hpe.com/us/en/about/environment/msds-specs-more.html> for more information



Overview

Platform Information

Form Factor

- 2U rack

Chassis Types

- 8 SFF with optional SFF or NVMe drive bay options
- 24 SFF bay with and 2 SFF rear drive bay option to total 26 SFF drives
- 8 LFF/12LFF chassis supporting SAS/SATA

System Fans

Standard – fan types included

- The 8 LFF and 8 SFF without standard fans included.
 - The 24 SFF chassis ships with 6 high performance fans as standard.
 - Max performance fan kits are required for >280w Processors SKUs, 12LFF/24SFF configurations, NVMe drives, 2SFF rear drives, some 100GbE & 200GbE networking cards, graphics cards, InfiniBand cards or if PCIe accelerators are being used.
-



Standard Features

Processors – One of the following depending on model.

Notes: For more information regarding AMD EPYC processors, please see the following:

<https://www.amd.com/en/products/epyc>

AMD EPYC Processor	Cores	Base Frequency	Max Frequency	Max Memory	Wattage	Cache	Memory
EPYC 7763	64	2.45 GHz	3.5 GHz	4TB	280W	256MB	3200MT/s
EPYC 7713P	64	2.0 GHz	3.675 GHz	4TB	225W	256MB	3200MT/s
EPYC 7663	56	2.0 GHz	3.5 GHz	4TB	240W	256MB	3200MT/s
EPYC 7643	48	2.3 GHz	3.6 GHz	4TB	225W	256MB	3200MT/s
EPYC 7543P	32	2.8 GHz	3.7 GHz	4TB	225W	256MB	3200MT/s
EPYC 7513	32	2.6 GHz	3.65 GHz	4TB	200W	128MB	3200MT/s
EPYC 7453	28	2.75 GHz	3.45 GHz	4TB	225W	64MB	3200MT/s
EPYC 7443P	24	2.85 GHz	4.0 GHz	4TB	200W	128MB	3200MT/s
EPYC 7413	24	2.65 GHz	3.6 GHz	4TB	180W	128MB	3200MT/s
EPYC 7343	16	3.2 GHz	3.9 GHz	4TB	190W	128MB	3200MT/s
EPYC 7313P	16	3.0 GHz	3.7 GHz	4TB	155W	128MB	3200MT/s
EPYC 75F3	32	2.95 GHz	4.0 GHz	4TB	280W	256MB	3200MT/s
EPYC 74F3	24	3.2 GHz	4.0 GHz	4TB	240W	256MB	3200MT/s
EPYC 73F3	16	3.5 GHz	4.0 GHz	4TB	240W	256MB	3200MT/s
EPYC 72F3	8	3.7 GHz	4.1 GHz	4TB	180W	256MB	3200MT/s
EPYC 7702P	64	2.0 GHz	3.35 GHz	4TB	200W	256MB	3200MT/s
EPYC 7502P	32	2.5 GHz	3.35 GHz	4TB	180W	128MB	3200MT/s
EPYC 7402P	24	2.8 GHz	3.35 GHz	4TB	180W	128MB	3200MT/s
EPYC 7302P	16	3.0 GHz	3.3 GHz	4TB	155W	128MB	3200MT/s
EPYC 7232P	8	3.1 GHz	3.2 GHz	4TB	120W	32MB	3200MT/s

Notes:

- All AMD EPYC processors can support up to 4TB of memory each.
- Rome processors can't support 2 DIMM per channel @3200MT/s. Rome processors support 2DPC @2933MT/s.

Chipset

No chipset – System on Chip (SoC) design.

On System Management Chipset

HPE iLO 5 ASIC

Read and learn more in the [iLO QuickSpecs](#).

Memory

One of the following depending on model

Type:	HPE DDR4 Smart Memory	Registered (RDIMM)
DIMM Slots Available	16	16 DIMM slots per processor, 8 channels per processor, 2 DIMMs per channel
Maximum capacity (RDIMM)	1.0 TB	16 x 64 GB RDIMM @ 3200 MT/S at 1 or 2 DPC
Maximum capacity (LRDIMM)	4.0 TB	16 x 256 GB LRDIMM @ 3200 MT/s at 1 DPC, 2933 MT/s at 2 DPC

Notes: The maximum memory speed is limited by the processor selection.



Standard Features

Memory Protection

Advanced ECC

Advanced ECC uses single device data correction to detect and correct single and all multibit error that occurs within a single DRAM chip.

Expansion Slots

Primary Riser

Notes:

- Bus width indicates the number of physical electrical lanes running to the connector.
- There are 2 types of risers supported on Primary Slot

Primary Riser1 (Defaulted Riser)

Slots #	Technology	Bus Width	Connector Width	Slot Form Factor
1	PCIe 4.0	X16	X16	Full-height,full-length slot
2	PCIe 4.0	X16	X16	Full-height,full-length slot

Primary Riser2*

Slots #	Technology	Bus Width	Connector Width	Slot Form Factor
1	NA	NA	NA	NA
2	PCIe 4.0	X16	X16	Full-height,full-length slot

Notes: * This riser kit cannot be selected as standalone. Must be selected along with HPE DL345 Gen10P U.3 24NVMe DA FIO Kit

Secondary Riser

Notes:

- Bus Width Indicates the number of physical electrical lanes running to the connector.
- There are 3 types of risers support on Secondary Slot
- The HPE DL345 Gen10+ 2x8 Slim Sec Riser Kit (P38643-B21) not listed here, cannot be selected as standalone. Must be selected along with HPE DL345 Gen10P U.3 24NVMe DA FIO Kit

Secondary Riser1

Slots #	Technology	Bus Width	Connector Width	Slot Form Factor
3	PCIe 4.0	X8	X16	Full-height,full-length slot
4	PCIe 4.0	X8	X16	Full-height,full-length slot

Secondary Riser2

Slots #	Technology	Bus Width	Connector Width	Slot Form Factor
3	PCIe 4.0	X16	X16	Full-height,full-length slot
4	NA	NA	NA	NA

Storage Controllers

The Gen10/Gen10 Plus controller naming framework has been updated to simplify identification as depicted below. For a more detailed breakout of the available Gen10/Gen10 Plus Smart Array controllers visit the

[HPE Smart Array Gen10 Controllers Data Sheet](#)

HPE also launched Tri-Mode controllers which will support NVMe U.3/U.2 drives as wells as SAS/SATA drives. Please see below list for the tri-mode controllers supported on the server.

NVMe Boot Device

- HPE NS204i-p NVMe PCIe3 OS Boot Device



Standard Features

Software RAID – HPE Smart Storage SR100i SR Gen10 Plus SW RAID

- All models feature an embedded storage controller, capable of operating on AHCI or SR100i modes, with embedded software supporting RAID for either up to 8 SATA drives or 2 U.3 NVMe SSDs.
- HPE Smart Storage SR100i SR Gen10 Plus SW RAID will operate in UEFI mode only. Legacy Mode (758959-B22) and SR100i Gen10 Plus SW RAID CAN NOT be selected together. For legacy support, an additional controller will be needed.
- Embedded SATA controller by default will work in AHCI Mode. HPE Smart Storage SR100i SR Gen10 Plus SW RAID can be enabled by selecting HPE SR100i Gen10 Plus Software RAID (P28417-B21).
- Supports Microsoft Windows Server only.

Notes: Requires SATA drives installed on following server/backplanes and drive bay position to support SR100i.

Part Number	Description	SR100i support
P26931-B21	HPE DL300 Gen10+ 2U 8SFF x4Tmode U.3 Kit	Up to 8 SATA drive at box 3 bay 1-8
P27194-B21	HPE DL300 Gen10+ 2U 8SFF x1Tmode U.3 Kit	Up to 8 SATA drive at box 3 bay 1-8
P38652-B21	HPE DL345 Gen10+ 8SFF BC Box1-2 Cage Kit	Up to 8 SATA drive at box 3 bay 1-8
P55516-B21	HPE DL38x Gen10+ 8SFF UBM2/TM BP Kit	Up to 8 SATA drive at box 3 bay 1-8
P38664-B21	HPE DL345 Gen10+ 8LFF CTO Server	Up to 8 SATA drives at box 2 bay 1-4 and box 3 bay 1-4
P39265-291	HPE DL345 Gen10+ 7232P 1P 32G 8LFF Server	Up to 8 SATA drives at box 2 bay 1-4 and box 3 bay 1-4

Notes: Requires NVMe drives installed on following backplanes and drive bay position to support SR100i.

Part Number	Description	SR100i support
P26931-B21	HPE DL300 Gen10+ 2U 8SFF x4Tmode U.3 Kit	Up to 2 NVMe drive at box 2 bay 5-6
P26932-B21	HPE DL300 Gen10+ 2U 8SFF x4 NVMe U.2 Kit	Up to 2 NVMe drive at box 2 bay 5-6
P27194-B21	HPE DL300 Gen10+ 2U 8SFF x1Tmode U.3 Kit	Up to 2 NVMe drive at box 2 bay 5-6
P38654-B21	HPE DL345 Gen10+ 2SFF U.3 BC BP Kit	Up to 2 NVMe drive at box 4 bay 1-2

Essential RAID Controller

- HPE Smart Array E208i-a SR G10 LH Controller
- HPE Smart Array E208e-p SR Gen10 Controller
- HPE Smart Array E208e-p SR Gen10 Controller

Performance RAID Controller

- HPE Smart Array P408i-a SR G10 LH Controller
- HPE Smart Array P408e-p SR Gen10 Controller
- HPE Smart Array P408i-p SR Gen10 Controller
- HPE Smart Array P816i-a SR G10 LH Controller

Notes: Performance RAID Controllers require the HPE 12W Smart Storage Battery (782961-B21) which is sold separately.

Tri-Mode RAID Controller

- HPE Tri-Mode MR216i-a Gen10 Plus Controller
- HPE Tri-Mode MR216i-p Gen10 Plus Controller
- HPE Tri-Mode MR416i-a Gen10 Plus Controller
- HPE Tri-Mode MR416i-p Gen10 Plus Controller
- HPE Tri-Mode SR416i-a Gen10 Plus Controller
- HPE Tri-Mode SR932i-p Gen10 Plus Controller



Standard Features

Internal Storage Devices

One of the following depending on model

Optical Drive

- None ship standard

Hard Drives

- None ship standard

Graphics

Integrated Video Standard

- Video modes up to 1920 x 1200@60Hz (32 bpp)
- 16MB Video Memory

HPE iLO 5 on system management memory

- 32 MB Flash
- 4 Gbit DDR 3 with ECC protection

Maximum Internal Storage

Drive	Capacity	Configuration
Hot Plug SFF SAS	62.4TB	24+2 x 2.4 TB (with optional rear SFF drive cage)
Hot Plug SFF SATA	52.0 TB	24+2 x 2 TB (with optional rear SFF drive cage)
Hot Plug LFF SAS	240 TB	12 x 20 TB
Hot Plug LFF SATA	240 TB	12 x 20 TB
Hot Plug SFF SAS SSD	399.36 TB	24+2 x 15.36 TB (with optional rear SFF drive cage)
Hot Plug LFF SATA SSD	11.52 TB	12 x 0.96 TB
Hot Plug SFF SATA SSD	199.7 TB	24+2 x 7.68 TB (with optional 2SFF drive cage)
Hot Plug SFF NVMe U.3 SSD	399.36TB NVMe U.3 (All U.3)	24+2 x 15.36TB NVMe (or 2x SAS/SATA with Max. storage depending on selection for SAS/SATA/HDD/SSD)
Hot Plug SFF NVMe U.2 SSD	184.3 TB NVMe U.2 (All U.2)	24 x 7.68 TB NVMe U.2 + 2 x SAS or SATA (Max. storage depending on selection for SAS/SATA/HDD/SSD)

Power Supply

- HPE 500W Flex Slot Platinum Hot Plug Low Halogen Power Supply Kit
Notes: Available in 94% Power Efficiency.
- HPE 800W Flex Slot Platinum Hot Plug Low Halogen Power Supply Kit
Notes: Available in 94%. Power Efficiency
- HPE 800W Flex Slot Titanium Hot Plug Low Halogen Power Supply Kit
Notes:
 - Available in 96% Power Efficiency
 - 200-240VAC power input only.
- HPE 800W Flex Slot Universal Hot Plug Low Halogen Power Supply Kit
Notes:
 - Available in 94% Power Efficiency
 - 277VAC power input.



Standard Features

- HPE 800W Flex Slot 48VDC Hot Plug Low Halogen Power Supply Kit
Notes:
 - Available in 94% Power Efficiency
 - -48VDC power input.
- HPE 1600W Flex Slot Platinum Hot Plug Low Halogen Power Supply Kit
Notes:
 - Available in 94% Power Efficiency.
 - 200-240VAC power input only.
- HPE 1600W 48VDC Power Supply Kit

HPE Flexible Slot (Flex Slot) Power Supplies share a common electrical and physical design that allows for hot plug, tool-less installation into HPE ProLiant Gen10 Plus Performance Servers. Flex Slot power supplies are certified for high-efficiency operation and offer multiple power output options, allowing users to "right-size" a power supply for specific server configurations. This flexibility helps to reduce power waste, lower overall energy costs, and avoid "trapped" power capacity in the data center.

All pre-configured servers ship with a standard 6-foot IEC C-13/C-14 jumper cord (A0K02A). This jumper cord is also included with each standard AC power supply option kit. If a different power cord is required, please check the [ProLiant Power Cables](#) web page.

To review the power requirements for your selected system, please use the [HPE Power Advisor Tool](#).

For information on power specifications and technical content visit [HPE Server power supplies](#).

Interfaces

Serial	Optional, rear
Display Port	N/A
VGA Port	1 rear
Network Ports	None. Choice of OCP or stand up card
HPE iLO Remote Management Network Port	1 Gb Dedicated
Front iLO Service Port	1 standard
USB 3.1 Gen1	Up to 4 total: 1 front, 2 rear, 1 internal
SID (Systems Insight Display)	N/A

Operating Systems and Virtualization Software Support for ProLiant Servers

- Windows Server 2016
- Windows Server 2019 (Most Recent Version)
- Windows Server 2022
- VMware ESXi 6.7 U3
- VMware ESXi 7.0 U1/U2
- **SUSE Linux Enterprise Server (SLES) 12 SP5**
- **SUSE Linux Enterprise Server (SLES) 15 SP2**
- **Red Hat Enterprise Linux (RHEL)**
 - AMD EPYC 7003 Series: 8.3
 - AMD EPYC 7002 Series: 7.6, 8.0
- Citrix Hypervisor 8.2
- Ubuntu 20.04 LTS



Standard Features

Notes: For more information on Hewlett Packard Enterprise Certified and Supported ProLiant Servers for OS and Virtualization Software and latest listing of software drivers available for your server.

<https://www.hpe.com/us/en/servers/server-operating-systems.html>

HPE Server UEFI/Legacy ROM

Unified Extensible Firmware Interface (UEFI) is an industry standard that provides better manageability and more secured configuration than the legacy ROM while interacting with your server at boot time. HPE ProLiant Gen10 Plus servers have a UEFI Class 2 implementation and support both UEFI Mode (default) and Legacy BIOS Mode.

Notes: The UEFI System Utilities tool is analogous to the HPE ROM-Based Setup Utility (RBSU) of legacy BIOS. For more information, please visit <http://www.hpe.com/servers/uefi>.

UEFI enables numerous new capabilities specific to HPE ProLiant servers such as:

- Secure Boot and Secure Start enable for enhanced security
- Operating system specific functionality
- Support for > 2.2 TB (using GPT) boot drives
- USB 3.0 Stack

HPE Server UEFI/Legacy ROM

- Embedded UEFI Shell
- Mass Configuration Deployment Tool using iLO RESTful API that is Redfish API Conformant
- PXE boot support for IPv6 networks
- Workload Profiles for simple performance optimization

UEFI Boot Mode only

- TPM 2.0 Support
- NVMe Boot Support
- iSCSI Software Initiator Support.
- HTTP/HTTPs Boot support as a PXE alternative.
- Boot support for option cards that only support a UEFI option ROM

Notes: For UEFI Boot Mode, boot environment and OS image installations should be configured properly to support UEFI.

Industry Standard Compliance

- ACPI 6.1 Compliant
- PCIe 4.0 Compliant
- WOL Support
- Microsoft® Logo certifications
- PXE Support
- VGA/Display Port
- USB 3.1 Gen1 Compliant (internal)
- USB 2.0 Compliant (external ports)
- Energy Star
- SMBIOS 3.1
- UEFI 2.6
- Redfish API
- IPMI 2.0



Standard Features

- Secure Digital 2.0
 - Advanced Encryption Standard (AES)
 - Triple Data Encryption Standard (3DES)
 - SNMP v3
 - TLS 1.2
 - DMTF Systems Management Architecture for Server Hardware Command Line Protocol (SMASH CLP)
 - Active Directory v1.0
 - European Union (EU) eco-design regulations for server and storage products, known as Lot 9, mandate that beginning on January 1st, 2024, units sold into the EU, European Economic Area (EEA), the United Kingdom, or Switzerland must include more efficient AC power supplies: 94% for multi-output and 96% for single-output. HPE Flexible Slot power supplies are single-output, and part numbers 865438-B21, P03178-B21, and P44712-B21 are 96% efficient, thus meeting requirements. HPE is on target to fulfil compliant systems ahead of time and will begin enforcing these requirements in advance to satisfy requests with the current power supplies by the set deadline.
 - ASHRAE A3/A4
 - Notes:** For additional technical thermal details regarding ambient temperatures, humidity and features support please visit: <http://www.hpe.com/servers/ashrae>.
 - UEFI (Unified Extensible Firmware Interface Forum)
-

Embedded Management

HPE Integrated Lights-Out (HPE iLO)

Monitor your servers for ongoing management, service alerting, reporting and remote management with HPE iLO.

Learn more at <http://www.hpe.com/info/ilo>.

UEFI

Configure and boot your servers securely with industry standard Unified Extensible Firmware Interface (UEFI).

Learn more at <http://www.hpe.com/servers/uefi>.

Intelligent Provisioning

Hassle free server and OS provisioning for 1 or more servers with Intelligent Provisioning.

Learn more at <http://www.hpe.com/servers/intelligentprovisioning>.

iLO RESTful API

iLO RESTful API is Redfish API conformance and offers simplified server management automation such as configuration and maintenance tasks based on modern industry standards.

Learn more at <http://www.hpe.com/info/restfulapi>.

Server Utilities

Active Health System

The HPE Active Health System (AHS) is an essential component of the iLO management portfolio that provides continuous, proactive health monitoring of HPE servers. Learn more at <http://www.hpe.com/servers/ahs>.

Active Health System Viewer

Use the Active Health System Viewer, a web-based portal, to easily read AHS logs and speed problem resolution with HPE self-repair recommendations, to learn more visit: <http://www.hpe.com/servers/ahsv>.



Standard Features

Smart Update

Keep your servers up to date with the HPE Smart Update solution by using Smart Update Manager (SUM) to optimize the firmware and driver updates of the Service Pack for ProLiant (SPP). Learn more at

<https://www.hpe.com/us/en/servers/smart-update.html>.

iLO Amplifier Pack

Designed for large enterprise and service provider environments with hundreds of HPE servers, the iLO Amplifier Pack is a free, downloadable open virtual application (OVA) that delivers the power to discover, inventory and update Gen8, Gen9, Gen10 & Gen10 Plus HPE servers at unmatched speed and scale. Use with an iLO Advanced License to unlock full capabilities.

Learn more at <http://www.hpe.com/servers/iLOamplifierpack>.

HPE iLO Mobile Application

Enables the ability to access, deploy, and manage your server anytime from anywhere from select smartphones and mobile devices.

For additional information please visit: <http://www.hpe.com/info/ilo/mobileapp>.

RESTful Interface Tool

RESTful Interface tool (iLOREST) is a single scripting tool to provision using iLO RESTful API to discover and deploy servers at scale. Learn more at <http://www.hpe.com/info/resttool>.

Scripting Tools

Provision one to many servers using your own scripts to discover and deploy with Scripting Tool (STK) for Windows and Linux or Scripting Tools for Windows PowerShell. Learn more at <http://www.hpe.com/servers/powershell>.

HPE OneView Standard

HPE OneView Standard can be used for inventory, health monitoring, alerting, and reporting without additional fees. It can monitor multiple HPE server generations. The user interface is similar to the HPE OneView Advanced version, but the software-defined functionality is not available. Learn more at <http://www.hpe.com/info/oneview>.

HPE Systems Insight Manager (HPE SIM)

Ideal for environments already using HPE SIM, it allows you to monitor the health of your HPE ProLiant Servers and HPE Integrity Servers. Also provides you with basic support for non-HPE servers. HPE SIM also integrates with Smart Update Manager to provide quick and seamless firmware updates. Learn more at <http://www.hpe.com/info/hpesim>.

Warranty

This product is covered by a global limited warranty and supported by HPE Services and a worldwide network of Hewlett Packard Enterprise Authorized Channel Partners resellers. Hardware diagnostic support and repair is available for three years from date of purchase. Support for software and initial setup is available for 90 days from date of purchase. Enhancements to warranty services are available through HPE Pointnext operational services or customized service agreements. Hard drives have either a one year or three year warranty; refer to the specific hard drive QuickSpecs for details.

Notes: Server Warranty includes 3-Year Parts, 3-Year Labor, 3-Year Onsite support with next business day response. Warranty repairs may be accomplished through the use of Customer Self Repair (CSR) parts. These parts fall into two categories: 1) Mandatory CSR parts are designed for easy replacement. A travel and labor charge will result when customers decline to replace a Mandatory CSR part; 2) Optional CSR parts are also designed for easy replacement but may involve added complexity. Customers may choose to have Hewlett Packard Enterprise replace Optional CSR parts at no charge. Additional information regarding worldwide limited warranty and technical support is available at: <https://www.hpe.com/us/en/search-results.html?page=1&q=servers%20warranty&autocomplete=0>



Standard Features

Security

- UEFI Secure Boot and Secure Start support
 - Immutable Silicon Root of Trust
 - FIPS 140-2 validation (iLO 5 certification in progress)
 - Common Criteria certification (iLO 5 certification in progress)
 - Configurable for PCI DSS compliance
 - Advanced Encryption Standard (AES) and Triple Data Encryption Standard (3DES) on browser
 - Support for Commercial National Security Algorithms (CNSA)
 - Tamper-free updates – components digitally signed and verified
 - Secure Recovery – recover critical firmware to known good state on detection of compromised firmware
 - Ability to rollback firmware
 - Secure erase of NAND/User data
 - TPM (Trusted Platform Module) 2.0 option
 - Bezel Locking Kit option
 - Chassis Intrusion detection option
-



Optional Features

Server Management

HPE iLO Advanced

HPE iLO Advanced licenses offer smart remote functionality without compromise, for all HPE ProLiant servers. The license includes the full integrated remote console, virtual keyboard, video, and mouse (KVM), multi-user collaboration, console record and replay, and GUI-based and scripted virtual media and virtual folders. You can also activate the enhanced security and power management functionality.

HPE iLO Advanced Premium Security Edition

HPE iLO Advanced Premium Security Edition for iLO 5 includes iLO Advanced License plus high-end security modes, unique security capabilities, like Automatic FW recovery; Runtime FW verification, and Secure erase. Learn more about HPE iLO Advanced Premium Security Edition at: <http://www.hpe.com/servers/ilopremium>.

HPE GreenLake for Compute Ops Management

HPE is intelligently transforming compute management with an intuitive cloud operating experience through HPE GreenLake cloud platform to streamline and secure operations from edge-to-cloud. Automated key lifecycle tasks, for onboarding, updating, managing, and monitoring HPE servers, brings agility and greater efficiencies to wherever compute devices reside via a unified single browser-based interface. Manage single locations or multiple, distributed sites. Keep tens to thousands of servers secure with batch policy controls and automated updates.

Compute Ops Management is cloud-native software that is continually updated with new services, features, patches, and fixes. The management application resides in the HPE GreenLake cloud platform (access via <https://console.greenlake.hpe.com>) and leverages the HPE GreenLake architecture, security, and unified operations.

For a complete list of software as-a-service subscription SKUs and more information, visit the HPE GreenLake for Compute Ops Management QuickSpecs: <https://www.hpe.com/psnow/doc/a50004263enw>

For information on supported HPE servers, the complete list can be found here: <https://www.hpe.com/info/com-supported-servers>

HPE OneView Advanced

HPE OneView brings a new level of automation to infrastructure management by taking a template driven approach to provisioning, updating, and integrating compute, storage, and networking infrastructure. It provides full-featured licenses which can be purchased for managing Gen8, Gen9, Gen10 & Gen10 Plus servers.

To learn more visit <http://www.hpe.com/info/oneview>.

HPE InfoSight for Servers

HPE InfoSight for Servers combines the cloud-based machine learning of InfoSight with the health and performance monitoring of Active Health System (AHS) and iLO to optimize performance and predict and prevent problems. The end result is an intelligent environment that modernizes IT operations and enhances the support experience by predicting and preventing the infrastructure issues that lead to application disruptions, wasted IT staff time and missed business opportunities.

Learn more at <https://www.hpe.com/servers/infosight>



Optional Features

Rack and Power Infrastructure

The story may end with servers, but it starts with the foundation that makes compute go – and business grow. We've reinvented our entire portfolio of rack and power products to make IT infrastructure more secure, more practical, and more efficient. In other words, we have created a stronger, smarter, and simpler infrastructure to help you get the most out of your IT equipment. As an industry leader, Hewlett Packard Enterprise is uniquely positioned to address the key concerns of power, cooling, cable management and system access.

HPE G2 Advanced and Enterprise Racks are perfect for the server room or today's modern data center with enhanced airflow and thermal management, flexible cable management, and a 10 year Warranty to support higher density computing. HPE G2 PDUs offer reliable power in flexible form factors that operate at temperatures up to 60°C, include color-coded outlets and load segments and a low-profile design for optimal access to the rack and support for dense rack environments.

HPE Uninterruptible Power Systems are cost-effective power protection for any type workload. Some UPSs include options for remote management and extended runtime modules so your critical dense data center is covered in power outages.

HPE KVM Solutions include a console and switches designed to work with your server and IT equipment reliably. We've got a cost-effective KVM switch for your first rack and multiple connection IP switches with remote management and security capabilities to keep your data center rack up and running.

Learn more about HPE Racks, KVM, PDUs and UPSs at [HPE Rack and Power Infrastructure](#).

One Config Simple (SCE)

SCE is a guided self-service tool to help sales and non-technical people provide customers with initial configurations in 3 to 5 minutes. You may then send the configuration on for configuration help, or use in your existing ordering processes. If you require "custom" rack configuration or configuration for products not available in SCE, please contact Hewlett Packard Enterprise Customer Business Center or an Authorized Partner for assistance. <https://h22174.www2.hpe.com/SimplifiedConfig/Welcome#>



Service and Support

HPE Pointnext - Service and Support

Get the most from your HPE Products. Get the expertise you need at every step of your IT journey with **HPE Pointnext Services**. We help you lower your risks and overall costs using automation and methodologies that have been tested and refined by HPE experts through thousands of deployments globally. HPE Pointnext **Advisory Services** focus on your business outcomes and goals, partnering with you to design your transformation and build a roadmap tuned to your unique challenges. Our **Professional** and **Operational Services** can be leveraged to speed up time-to-production, boost performance and accelerate your business. HPE Pointnext specializes in flawless and on-time implementation, on-budget execution, and creative configurations that get the most out of software and hardware alike.

Consume IT on your terms

HPE GreenLake brings the cloud experience directly to your apps and data wherever they are—the edge, colocations, or your data center. It delivers cloud services for on-premises IT infrastructure specifically tailored to your most demanding workloads. With a pay-per-use, scalable, point-and-click self-service experience that is managed for you, HPE GreenLake accelerates digital transformation in a distributed, edge-to-cloud world.

- Get faster time to market
- Save on TCO, align costs to business
- Scale quickly, meet unpredictable demand
- Simplify IT operations across your data centers and clouds

Managed services to run your IT operations

HPE GreenLake Management Services provides services that monitor, operate, and optimize your infrastructure and applications, delivered consistently and globally to give you unified control and let you focus on innovation.

Recommended Services

HPE Pointnext Tech Care.

HPE Pointnext Tech Care is the new operational service experience for HPE products. Tech Care goes beyond traditional support by providing access to product specific experts, an AI driven digital experience, and general technical guidance to not only reduce risk but constantly search for ways to do things better. HPE Pointnext Tech Care has been reimagined from the ground up to support a customer-centric, AI driven, and digitally enabled customer experience to move your business forward. HPE Pointnext Tech Care is available in three response levels. Basic, which provides 9x5 business hour availability and a 2 hour response time. Essential which provides a 15 minute response time 24x7 for most enterprise level customers, and Critical which includes a 6 hour repair commitment where available and outage management response for severity 1 incidents.

<https://www.hpe.com/services/techcare>

HPE Pointnext Complete Care

HPE Pointnext Complete Care is a modular, edge-to-cloud IT environment service that provides a holistic approach to optimizing your entire IT environment and achieving agreed upon IT outcomes and business goals through a personalized and customer-centric experience. All delivered by an assigned team of HPE Pointnext Services experts. HPE Pointnext Complete Care provides:

- A complete coverage approach -- edge to cloud
- An assigned HPE team
- Modular and fully personalized engagement
- Enhanced Incident Management experience with priority access
- Digitally enabled and AI driven customer experience

<https://www.hpe.com/services/complecare>



Service and Support

Other related Services

HPE Server Hardware Installation

Provides for the basic hardware installation of HPE branded servers, storage devices and networking options to assist you in bringing your new hardware into operation in a timely and professional manner.

<https://h20195.www2.hpe.com/v2/Getdocument.aspx?docname=5981-9356enw>

HPE Installation and Startup Service

Provides for the installation of your HPE hardware according to product specifications including options. The HPE service delivery technician will connect the product to a LAN as appropriate and enable remote support to allow for automatic case creation for hardware failures. Installation and start up services also includes the installation of one supported operating system type (Windows® or Linux).

DC for Hyperscale

Complete Care for Hyperscale is available for Service Providers and HPC customers who use a scale out approach to computing with a high volume homogenous infrastructure and resilient architecture can take advantage of this environment support tailored to their operating model.

HPE Factory Express for Servers and storage

HPE Factory Express offers configuration, customization, integration and deployment services for HPE servers and storage products. Customers can choose how their factory solutions are built, tested, integrated, shipped and deployed.

Factory Express offers service packages for simple configuration, racking, installation, complex configuration and design services as well as individual factory services, such as image loading, asset tagging, and custom packaging. HPE products supported through Factory Express include a wide array of servers and storage: HPE Integrity, HPE ProLiant, HPE Apollo, HPE ProLiant Server Blades, HPE BladeSystem, HPE 9000 servers as well as the MSAxxx3PAR suite, XP, rackable tape libraries and configurable network switches.

HPE Service Credits

HPE Service Credits offers flexible services and technical skills to meet your changing IT demands. With a menu of service that is tailored to suit your needs, you get additional resources and specialist skills to help you maintain peak performance of your IT. Offered as annual credits, you can plan your budgets while proactively responding to your dynamic business.

HPE Education Services

Keep your IT staff trained making sure they have the right skills to deliver on your business outcomes. Book on a class today and learn how to get the most from your technology investment. <http://www.hpe.com/ww/learn>



Service and Support

HPE Support Center

The HPE Support Center is a personalized online support portal with access to information, tools and experts to support HPE business products. Submit support cases online, chat with HPE experts, access support resources or collaborate with peers.

Learn more <http://www.hpe.com/support/hpesc>.

The HPE Support Center Mobile App* allows you to resolve issues yourself or quickly connect to an agent for live support. Now, you can get access to personalized IT support anywhere, anytime.

HPE Insight Remote Support and HPE Support Center are available at no additional cost with a HPE warranty, HPE Support Service or HPE contractual support agreement.

Notes: *HPE Support Center Mobile App is subject to local availability.

For more information: <http://www.hpe.com/services>.

Notes: HPE ProLiant DL385 Gen10 Plus Server is covered under the HPE Service Contract applied to the HPE ProLiant Server. No separate HPE support services need to be purchased.

Warranty and Support Services will extend to include HPE options configured with your server or storage device. The price of support service is not impacted by configuration details. HPE sourced options that are compatible with your product will be covered under your server support at the same level of coverage allowing you to upgrade freely. Installation for HPE options is available as needed. To keep support costs low for everyone, some high value options will require additional support. Additional support is only required on select high value workload accelerators, fibre switches, InfiniBand and UPS batteries over 12KVA. See the specific high value options that require additional support [here](#).

Parts and Materials

Hewlett Packard Enterprise will provide HPE-supported replacement parts and materials necessary to maintain the covered hardware product in operating condition, including parts and materials for available and recommended engineering improvements.

Parts and components that have reached their maximum supported lifetime and/or the maximum usage limitations as set forth in the manufacturer's operating manual, product QuickSpecs, or the technical product data sheet will not be provided, repaired, or replaced as part of these services.

The defective media retention service feature option applies only to Disk or eligible SSD/Flash Drives replaced by Hewlett Packard Enterprise due to malfunction.



Pre-configured Models

Entry, Base and Performance Models			
SKU Number	P39265-B21 P39265-291	P39266-B21 P39266-291	P39267-B21 P39267-291
Model Name	HPE ProLiant DL345 Gen10 Plus 7232P 3.1GHz 8-core 1P 32GB-R 8LFF 500W PS Server	HPE ProLiant DL345 Gen10 Plus 7313P 3.0GHz 16-core 1P 32GB-R 8SFF 500W PS Server	HPE ProLiant DL345 Gen10 Plus 7443P 2.85GHz 24-core 1P 32GB-R 8SFF 500W PS Server
Processor	7232P (8-Core, 3.1 GHz, 120W)	7313P (16-Core, 3.0 GHz, 155W)	7443P (24-Core, 2.85 GHz, 200W)
Number of Processors	One processor	One processor	One processor
Memory	32 GB RDIMM DR 3200 MT/s (1x 32 GB)	32 GB RDIMM DR 3200 MT/s (1x 32 GB)	32 GB RDIMM DR 3200 MT/s (1x 32 GB)
Network Controller	HPE 1GbE 4-port OCP3 Adapter plus choice of OCP or standup card	HPE 1GbE 4-port OCP3 Adapter plus choice of OCP or standup card	HPE 10GbE 2-port OCP3 Adapter plus choice of OCP or standup card
Storage Controller	P408i-a SR Notes: 8-Port modular Smart Array.	P408i-a SR Notes: 8-Port modular Smart Array.	P408i-a SR Notes: 8-Port modular Smart Array.
Hard Drive	None ship as standard	None ship as standard	None ship as standard
Internal Storage	8 LFF chassis (upgradeable to 12LFF in front + 2SFF rear)	8 SFF chassis (upgradeable to 24SFF in front + 2SFF rear)	8 SFF chassis (upgradeable to 24SFF in front + 2SFF rear)
Optical Drive Bay	Optional	Optional	Optional
Optical Drive	None ship as standard	None ship as standard	None ship as standard
PCI-Express Slots	3-slots (x16, x16 in primary) as standard	3-slots (x16, x16 in primary) as standard	3-slots (x16, x16 in primary) as standard
Power Supply	1x 500W HPE FlexSlot Power Supply	1x 500W HPE FlexSlot Power Supply	1x 800W HPE FlexSlot Power Supply
Fans	6-standard fans	6-standard fans	6-standard fans
Management	Default: HPE iLO Standard with Intelligent Provisioning, HPE OneView Standard (requires download) Optional (require licenses): HPE iLO Advanced, HPE iLO Advanced Premium Security Edition, HPE OneView Advanced	Default: HPE iLO Standard with Intelligent Provisioning, HPE OneView Standard (requires download) Optional (require licenses): HPE iLO Advanced, HPE iLO Advanced Premium Security Edition, HPE OneView Advanced	Default: HPE iLO Standard with Intelligent Provisioning, HPE OneView Standard (requires download) Optional (require licenses): HPE iLO Advanced, HPE iLO Advanced Premium Security Edition, HPE OneView Advanced
Energy Star	3.0 certified	3.0 certified	3.0 certified
Form Factor	2U Rack, LFF Easy Install rails with optional CMA	2U Rack, LFF Easy Install rails with optional CMA	2U Rack, LFF Easy Install rails with optional CMA
Warranty	3-year parts, 3-year labor, 3-year onsite support with next business day response.	3-year parts, 3-year labor, 3-year onsite support with next business day response.	3-year parts, 3-year labor, 3-year onsite support with next business day response.

Country Code Key

xx1 = B21 Worldwide

xx1 = 291 Japan

Notes: The -B21 WW SKU is to be ordered in all countries other than Japan.

Configuration Information

European Union (EU) eco-design regulations for server and storage products, known as Lot 9, mandate that beginning on January 1st, 2024, units sold into the EU, European Economic Area (EEA), the United Kingdom, or Switzerland must include more efficient AC power supplies: 94% for multi-output and 96% for single-output. HPE Flexible Slot power supplies are single-output, and part numbers 865438-B21, P03178-B21, and P44712-B21 are 96% efficient, thus meeting requirements. HPE is on target to fulfil compliant systems ahead of time and will begin enforcing these requirements in advance to satisfy requests with the current power supplies by the set deadline.

This section lists some of the steps required to configure a Factory Integrated Model. To ensure only valid configurations are ordered, Hewlett Packard Enterprise recommends the use of an HPE approved configurator. Contact your local sales representative for information on configurable product offerings and requirements.

- Factory Integrated Models must start with a CTO Server.
- FIO indicates that this option is only available as a factory installable option.
- All Factory Integrated Models will be populated with sufficient hard drive blanks based on the number of initial hard drives ordered with the server.
- Some options may not be integrated at the factory. Contact your local sales representative for additional information.

Step 1: Base Configuration (choose one of the following configurable models)

CTO Server	HPE ProLiant DL345 Gen10 Plus 8 LFF CTO Server	HPE ProLiant DL345 Gen10 Plus 8 SFF CTO Server	HPE ProLiant DL345 Gen10 Plus 24 SFF CTO Server
SKU Number	P38664-B21	P38665-B21	P38666-B21
Processor	Not included as standard	Not included as standard	Not included as standard
DIMM Slots	16-DIMM slots	16-DIMM slots	16-DIMM slots
Storage Controller	Choice of HPE modular Smart Array and PCIe plug-in controller		
PCIe	Two standard in primary riser, up to four slots with a secondary riser		
Drive Cage - included	8 LFF	8 SFF	24 SFF
Network Controller	Choice of OCP or stand up card		
Fans	Not included as standard	Not included as standard	6-Performance
Management	HPE iLO with Intelligent Provisioning (standard), iLO Advanced and OneView (optional)		
USB	1x 3.0 standard plus iLo front service port		

Notes:

- HPE offers multiple Trade Agreement Act (TAA) compliant configurations to meet the needs of US Federal Government customers. These products are either manufactured or substantially transformed in a designated country. TAA compliance is only provided when HPE options are included as part of factory integrated orders (CTO).
- TAA compliant configuration requires TAA versions of the CTO Server SKUs.
- All CTO servers are Energy Star 3.0 compliant.

CTO Server	8 LFF CTO Chassis	8 SFF CTO Chassis	24 SFF CTO Chassis
Included Drive Cage	1x 8 LFF SAS/SATA	1x 8 SFF SAS/SATA	3x 8 SFF SAS/SATA
Universal Media Bay	Not available	Not available	Not available
ODD	Not available	Not available	Not available
4 LFF SAS/SATA	Up to 1 Optional	Not available	Not available
8 SFF SAS/SATA Drive Cage	Not available	Up to 1 Optional	Not available
8 SFF NVMe Drive Cage	Not available	Up to 2 Optional	Not available
8 SFF SAS/SATA/NVMe (Mid- plane)	Not available	8 SFF CTO Chassis	Not available
2 SFF SAS/SATA (Front)	Not available	1x 8 SFF SAS/SATA	Not available
2 SFF SAS/SATA/NVMe (Rear)	1 Optional	Not available	1 Optional
2 NVMe (Front)	Not available	Not available	Not available
4 LFF Mid-plane	Not available	Not available	Not available
4 LFF Rear	Not available	Not available	Not available

Notes: This applies to CTO configurations, field upgrades may differ depending field configuration.



Configuration Information

Step 2: Choose Required Options (only one of the following unless otherwise noted)

Notes:

- 8 SFF and 8 LFF CTO chassis don't have fans included. 3 q'ty of Standard Fan Kit (P37042-B21) must be selected if 8 SFF or 8 LFF CTO chassis is in the order. 24 SFF CTO chassis has 6 Performance Fans as standard.
- Processors with greater than or equal to 180W will need the High Performance heatsink.
- Processors equal to 280W will require the Max Performance fan kit.

Step 2a: Choose Processors

Description	SKU
Processor Option Kits AMD EPYC 7763 2.45GHz 64-core 280W Processor for HPE	P38696-B21
Notes: <ul style="list-style-type: none"> – This processor doesn't include a fan kit or a heat sink kit. – Processors equal to 280W will require the Max Performance fan kit. – Processors with greater than or equal to 180W will need the High Performance Heat Sink Kit (P38655-B21). 	
AMD EPYC 7713P 2.0GHz 64-core 225W Processor for HPE	P38720-B21
Notes: <ul style="list-style-type: none"> – This processor doesn't include a fan kit or a heat sink kit. – This processor needs selection of 3 q'ty of Standard Fan Kit (P37042-B21) – Processors with greater than or equal to 180W will need the High Performance Heat Sink Kit (P38655-B21) 	
AMD EPYC 7663 2.0GHz 56-core 240W Processor for HPE	P38690-B21
Notes: <ul style="list-style-type: none"> – This processor doesn't include a fan kit or a heat sink kit. – This processor needs selection of 3 q'ty of Standard Fan Kit (P37042-B21) – Processors with greater than or equal to 180W will need the High Performance Heat Sink Kit (P38655-B21) 	
AMD EPYC 7643 2.3GHz 48-core 225W Processor for HPE	P39365-B21
Notes: <ul style="list-style-type: none"> – This processor doesn't include a fan kit or a heat sink kit. – This processor needs selection of 3 q'ty of Standard Fan Kit (P37042-B21) – Processors with greater than or equal to 180W will need the High Performance Heat Sink Kit (P38655-B21) 	
AMD EPYC 75F3 2.95GHz 32-core 280W Processor for HPE	P38708-B21
Notes: <ul style="list-style-type: none"> – This processor doesn't include a fan kit or a heat sink kit. – Processors equal to 280W will require the Max Performance fan kit. – Processors with greater than or equal to 180W will need the High Performance Heat Sink Kit (P38655-B21). 	
AMD EPYC 7543P 2.8GHz 32-core 225W Processor for HPE	P38717-B21
Notes: <ul style="list-style-type: none"> – This processor doesn't include a fan kit or a heat sink kit. – This processor needs selection of 3 q'ty of Standard Fan Kit (P37042-B21) – Processors with greater than or equal to 180W will need the High Performance Heat Sink Kit (P38655-B21) 	



Configuration Information

AMD EPYC 7513 2.6GHz 32-core 200W Processor for HPE

P38684-B21

Notes:

- This processor doesn't include a fan kit or a heat sink kit.
- This processor needs selection of 3 q'ty of Standard Fan Kit (P37042-B21)
- Processors with greater than or equal to 180W will need the High Performance Heat Sink Kit (P38655-B21)

AMD EPYC 7453 2.75GHz 28-core 225W Processor for HPE

P38678-B21

Notes:

- This processor doesn't include a fan kit or a heat sink kit.
- This processor needs selection of 3 q'ty of Standard Fan Kit (P37042-B21)
- Processors with greater than or equal to 180W will need the High Performance Heat Sink Kit (P38655-B21)

AMD EPYC 74F3 3.2GHz 24-core 240W Processor for HPE

P38705-B21

Notes:

- This processor doesn't include a fan kit or a heat sink kit.
- This processor needs selection of 3 q'ty of Standard Fan Kit (P37042-B21)
- Processors with greater than or equal to 180W will need the High Performance Heat Sink Kit (P38655-B21)

AMD EPYC 7443P 2.85GHz 24-core 200W Processor for HPE

P38714-B21

Notes:

- This processor doesn't include a fan kit or a heat sink kit.
- This processor needs selection of 3 q'ty of Standard Fan Kit (P37042-B21)
- Processors with greater than or equal to 180W will need the High Performance Heat Sink Kit (P38655-B21)

AMD EPYC 7413 2.65GHz 24-core 180W Processor for HPE

P38675-B21

Notes:

- This processor doesn't include a fan kit or a heat sink kit.
- This processor needs selection of 3 q'ty of Standard Fan Kit (P37042-B21)
- Processors with greater than or equal to 180W will need the High Performance Heat Sink Kit (P38655-B21)

AMD EPYC 73F3 3.5GHz 16-core 240W Processor for HPE

P38702-B21

Notes:

- This processor doesn't include a fan kit or a heat sink kit.
- This processor needs selection of 3 q'ty of Standard Fan Kit (P37042-B21)
- Processors with greater than or equal to 180W will need the High Performance Heat Sink Kit (P38655-B21)

AMD EPYC 7343 3.2GHz 16-core 190W Processor for HPE

P38672-B21

Notes:

- This processor doesn't include a fan kit or a heat sink kit.
- This processor needs selection of 3 q'ty of Standard Fan Kit (P37042-B21)
- Processors with greater than or equal to 180W will need the High Performance Heat Sink Kit (P38655-B21)

AMD EPYC 7313P 3.0GHz 16-core 155W Processor for HPE

P38711-B21

Notes:

- This processor doesn't include a fan kit or a heat sink kit.
- This processor needs selection of 3 q'ty of Standard Fan Kit (P37042-B21)
- This processor needs selection of a Standard Heat Sink Kit (P38656-B21)



Configuration Information

AMD EPYC 72F3 3.7GHz 8-core 180W Processor for HPE

P38699-B21

Notes:

- This processor doesn't include a fan kit or a heat sink kit.
- This processor needs selection of 3 q'ty of Standard Fan Kit (P37042-B21)
- Processors with greater than or equal to 180W will need the High Performance Heat Sink Kit (P38655-B21)

DL345 Gen10 Plus also supports AMD EPYC 2nd Generation Processors

AMD EPYC 7502P 2.5GHz 32-core 180W Processor Kit for HPE

P39735-B21

Notes:

- This processor doesn't include a fan kit or a heat sink kit.
- This processor needs selection of 3 q'ty of Standard Fan Kit (P37042-B21)
- Processors with greater than or equal to 180W will need the High Performance Heat Sink Kit (P38655-B21)

AMD EPYC 7302P 3.0GHz 16-core 155W Processor Kit for HPE

P39737-B21

Notes:

- This processor doesn't include a fan kit or a heat sink kit.
- This processor needs selection of 3 q'ty of Standard Fan Kit (P37042-B21)
- This processor needs selection of a Standard Heat Sink Kit (P38656-B21)

AMD EPYC 7232P 3.1GHz 8-core 120W Processor Kit for HPE

P39738-B21

Notes:

- This processor doesn't include a fan kit or a heat sink kit.
- This processor needs selection of 3 q'ty of Standard Fan Kit (P37042-B21)
- This processor needs selection of a Standard Heat Sink Kit (P38656-B21)

Supporting Ambient Temp. Limitation

Chassis config	12LFF/24SFF/24 NVMe	8LFF/16SFF/16 NVMe
280W CPU	25C	25C
Rear NVMe drives (For 7.68TB & 15.35TB drives)	30C	35C

Step 2b: Choose Memory Options

Please select one or more memory from below.

For new Gen10 Plus memory population rule whitepaper and optimal memory performance guidelines, please go to:

<http://www.hpe.com/docs/amd-population-rules-Gen10Plus>

For Gen10 Plus memory speed table, please go to: <http://www.hpe.com/docs/amd-speed-table-Gen10Plus>

Notes:

- Memory DIMM availability with a server platform is dependent upon completion of certification testing.
- The maximum memory speed is a function of the memory type, memory configuration, and processor model.
- Memory compatibility may vary or be limited within a specific server family depending upon the specific configuration being requested. Because each server environment and requirements can vary, memory compatibility is based not only upon the server family, but may also be affected by the amount and type of additional hardware options installed within a specific server configuration. For this reason, some HPE memory DIMMs may be qualified for a server model or family and yet occasionally not be supported with limited configurations within that server family. Please consult with the HPE server Quickspecs or your HPE representative if you have any questions regarding memory compatibility with a specific HPE server configuration.

Registered DIMMs (RDIMMs)

HPE 8GB (1x8GB) Single Rank x8 DDR4-3200 CAS-22-22-22 Registered Smart Memory Kit

P07638-B21

HPE 16GB (1x16GB) Single Rank x4 DDR4-3200 CAS-22-22-22 Registered Smart Memory Kit.

P07640-B21



Configuration Information

HPE 16GB (1x16GB) Dual Rank x8 DDR4-3200 CAS-22-22-22 Registered Smart Memory Kit	P07642-B21
HPE 32GB (1x32GB) Single Rank x4 DDR4-3200 CAS-22-22-22 Registered Memory Kit	P38454-B21
HPE 32GB (1x32GB) Dual Rank x4 DDR4-3200 CAS-22-22-22 Registered Smart Memory Kit	P07646-B21
HPE 64GB (1x64GB) Dual Rank x4 DDR4-3200 CAS-22-22-22 Registered Smart Memory Kit	P07650-B21
HPE 128GB (1x128GB) Quad Rank x4 DDR4-3200 CAS-22-22-22 Load Reduced Smart Memory Kit	P07652-B21
HPE 256GB (1x256GB) Octal Rank x4 DDR4-3200 CAS-26-22-22 Load Reduced 3DS Smart Memory Kit	P07654-B21

256GB DIMM Support Ambient Temperature Limitations

System Config	Ambient Temp. Limitation
12LFF	Not supportable with 12LFF
8LFF	30C
24SFF/16SFF/16NVMe	30C
8SFF/ 8NVMe	35C
24NVMe	25C

Notes:

- Mixing of x4 & x8 memory is not allowed
- 8GB~128GB memory SKUs can run the transfer rate of 3200 MT/s at both 1 DIMM and 2 DIMM per channel
- 256GB memory SKU can run the transfer rate of 3200 MT/s at 1 DIMM per channel, but only 2933 MT/s at 2 DIMM per channel

Step 2c: Choose Power Supplies

Select one or two power supplies from below.

Notes: Mixing of 2 different power supplies is NOT allowed.

HPE Flex Slot Power Supplies

HPE 500W Flex Slot Platinum Hot Plug Low Halogen Power Supply Kit	865408-B21
HPE 800W Flex Slot Titanium Hot Plug Low Halogen Power Supply Kit	865438-B21
HPE 800W Flex Slot Platinum Hot Plug Low Halogen Power Supply Kit	P38995-B21
HPE 800W Flex Slot -48VDC Hot Plug Low Halogen Power Supply Kit	865434-B21
HPE 800W Flex Slot Universal Hot Plug Low Halogen Power Supply Kit	865428-B21
HPE 1600W Flex Slot Platinum Hot Plug Low Halogen Power Supply Kit	P38997-B21
HPE 1600W Flex Slot -48VDC Hot Plug Power Supply Kit	P17023-B21
HPE 1600W -48VDC Power Cable Lug Kit	P36877-B21

Notes:

- P36877-B21 is to be used with HPE 1600W Flex Slot -48VDC Power Supply Kit
- Only one power cable lug kit needs to be selected with the power supply

Notes:

- Select one or more power supplies.
- 1600W Power supplies only support high line voltage (200VAC to 240VAC).
- Prior to making a power supply selection it is highly recommended that the HPE Power Advisor is run to determine the right size power supply for your server configuration. The HPE Power Advisor is located at: <http://www.hpe.com/info/hppoweradvisor>.
- All power supplies in a server should match. Mixing Power Supplies is not supported.
- HPE ProLiant servers ship with an IEC-IEC power cord used for rack mounting with Power Distribution Units (PDUs). Visit [HPE power cords](#) for a full list of optional power cords.



Configuration Information

Step 3: Choose Additional Factory Integratable Options

One of the following from each list may be selected if desired at time of factory integration

HPE Unique Options

HPE ProLiant DL345 Gen10 Plus x16 Slimline Primary Riser Kit P38637-B21

Notes:

- This riser must be selected only if HPE DL345 Gen10P U.3 24NVMe DA FIO Kit is in the order
- The HPE DL345 Gen10 Plus x16 Slimline Primary Riser Kit and HPE DL345 Gen10P 2x8 Secondary Riser Kit or HPE DL345 Gen10P x16 Secondary Riser Kit cannot be selected and vice versa.
- Max= 2 of the below riser can be selected
 - HPE DL345 Gen10P 2x8 Slimline SEC Rsr Kit
 - HPE DL345 Gen10P x16 Slimline Primary Rsr Kit

HPE ProLiant DL345 Gen10 Plus x8/x8 Secondary Riser Kit P38639-B21

Notes:

- Max= 1 of the below riser can be selected.
 - HPE DL345 Gen10P 2x8 SEC Rsr Kit P38639-B21
 - HPE DL345 Gen10P x16 SEC Rsr Kit P38641-B21
- The HPE DL345 Gen10 Plus x16 Slimline Primary Riser Kit and HPE DL345 Gen10P 2x8 Secondary Riser Kit or HPE DL345 Gen10P x16 Secondary Riser Kit cannot be selected and vice versa.

HPE ProLiant DL345 Gen10 Plus x16 Secondary Riser Kit P38641-B21

Notes:

- Max= 1 of the below riser can be selected.
 - HPE DL345 Gen10P 2x8 SEC Rsr Kit P38639-B21
 - HPE DL345 Gen10P x16 SEC Rsr Kit P38641-B21
- The HPE DL345 Gen10 Plus x16 Slimline Primary Riser Kit and HPE DL345 Gen10P 2x8 Secondary Riser Kit or HPE DL345 Gen10P x16 Secondary Riser Kit cannot be selected and vice versa.

HPE ProLiant DL345 Gen10 Plus x8/x8 Slimline Secondary Riser Kit P38643-B21

Notes:

- This riser must be selected only if HPE DL345 Gen10P U.3 24NVMe DA FIO Kit is in the order
- The HPE DL345 Gen10 Plus x16 Slimline Primary Riser Kit and HPE DL345 Gen10P 2x8 Secondary Riser Kit or HPE DL345 Gen10P x16 Secondary Riser Kit cannot be selected and vice versa.
- Max= 2 of the below riser can be selected
 - HPE DL345 Gen10P 2x8 Slimline SEC Rsr Kit
 - HPE DL345 Gen10P x16 Slimline Primary Rsr Kit

HPE ProLiant DL345 Gen10 Plus 8NVMe U.3 Direct FIO Bundle Kit P38648-B21

Notes:

- If this bundle kit is selected then HPE DL345 Gen10 Plus 8NVMe DA Cable Kit (P38659-B21) must be selected too.
- This option can be selected only if 8SFF NVMe x4 U.3 drive cage or 8SFF NVMe x4 U.2 drive cage is selected.

HPE ProLiant DL345 Gen10 Plus 16NVMe U.3 Direct FIO Bundle Kit P38649-B21

Notes:

- If this bundle kit is selected then the following kits should also be selected:
 - HPE DL345 Gen10 Plus 16NVMe DA Cable Kit (P38660-B21)
 - HPE DL345 Gen10 Plus AROC NVMe Adpt Kit (P39271-B21)
- This option can be selected only if 8SFF NVMe x4 U.3 drive cage or 8SFF NVMe x4 U.2 drive cage is selected.



Configuration Information

HPE ProLiant DL345 Gen10 Plus 24NVMe U.3 Direct FIO Bundle Kit

P38650-B21

Notes:

- If this bundle kit is selected then the following kits should also be selected:
 - HPE DL345 Gen10 Plus 24NVMe DA Cable Kit (P38661-B21)
 - HPE DL345 Gen10P x16 Slimline Primary Riser Kit (P38637-B21)
 - HPE DL345 Gen10P 2x8 Slimline Secondary Riser Kit (P38643-B21)
 - HPE DL345 Gen10P AROC NVMe Adpt Kit (P39271-B21)
 - HPE 8SFF Front Remove SPEC Perf FIO (873763-B21)
- This option can be selected only if 8SFF NVMe x4 U.3 drive cage or 8SFF NVMe x4 U.2 drive cage is selected.

HPE DL38X Gen10 8 SFF Front Cage Removal FIO Option

873763-B21

Notes:

- This is a factory integrated only option.
- If 3 q'ty of 8SFF NVMe x1 U.3 drive cage or 3 q'ty of 8SFF NVMe x4 U.3 drive cage or 3 q'ty of 8SFF NVMe x4 U.2 drive cage is selected then this option must be selected.

HPE Security Options

HPE Server Security Optimized Service for HPE ProLiant (R9S59A) is an optional security upgrade intended for agencies and regulated industries with enhanced security and compliance needs. Applying this option to a DL3XX Gen10/Gen10 Plus CTO server ensures it is hardened by turning on advanced safeguards in place against cyber-exploits throughout the server lifecycle. An iLO Advanced License required for High Security Mode and compatible intrusion detection device option kits are prerequisites for the full optimization service.

Step 4: Choose additional options for Factory Integration from Core and Additional Options sections below



Core Options

Some options may not be integrated at the factory. To ensure only valid configurations are ordered, Hewlett Packard Enterprise recommends the use of an HPE approved configurator. Contact your local sales representative for additional information.

HPE Unique Options

HPE ProLiant DL345 Gen10 Plus Smart Array to NVMe Adapter Kit P39271-B21

Notes:

- Used to support up to 16 NVMe drives with Modular Controller (AROC).
- This kit cannot be selected as standalone. Must be selected only if below any one of the option is in the order
 - HPE DL345 Gen10P U.3 16NVMe DA FIO kit (P38649-B21)
 - HPE DL345 Gen10P U.3 24NVMe DA FIO Kit (P38650-B21)

HPE ProLiant DL345 Gen10 Plus 12Gb SAS Expander Card P39270-B21

Notes:

- This option cannot be selected with 8 LFF or 8 SFF CTO chassis.
- Max= 1 of this option must be selected with a 24 SFF CTO chassis.
- If this option is selected then P816i-a/P408i-a/E208i-a controller must be selected.
- This option can only be supported in the default primary riser.

HPE Processors

AMD EPYC 3rd Generation Processors

AMD EPYC 7763 2.45GHz 64-core 280W Processor for HPE P38696-B21

Notes:

- This processor doesn't include a fan kit or a heat sink kit.
- Processors equal to 280W will require the Max Performance fan kit.
- Processors with greater than or equal to 180W will need the High Performance Heat Sink Kit (P38655-B21).

AMD EPYC 7713P 2.0GHz 64-core 225W Processor for HPE P38720-B21

Notes:

- This processor doesn't include a fan kit or a heat sink kit.
- This processor needs selection of 3 q'ty of Standard Fan Kit (P37042-B21)
- Processors with greater than or equal to 180W will need the High Performance Heat Sink Kit (P38655-B21)

AMD EPYC 7663 2.0GHz 56-core 240W Processor for HPE P38690-B21

Notes:

- This processor doesn't include a fan kit or a heat sink kit.
- This processor needs selection of 3 q'ty of Standard Fan Kit (P37042-B21)
- Processors with greater than or equal to 180W will need the High Performance Heat Sink Kit (P38655-B21)

AMD EPYC 7643 2.3GHz 48-core 225W Processor for HPE P39365-B21

Notes:

- This processor doesn't include a fan kit or a heat sink kit.
- This processor needs selection of 3 q'ty of Standard Fan Kit (P37042-B21)
- Processors with greater than or equal to 180W will need the High Performance Heat Sink Kit (P38655-B21)

AMD EPYC 75F3 2.95GHz 32-core 280W Processor for HPE P38708-B21

Notes:

- This processor doesn't include a fan kit or a heat sink kit.
- Processors equal to 280W will require the Max Performance fan kit.



Core Options

- Processors with greater than or equal to 180W will need the High Performance Heat Sink Kit (P38655-B21).

AMD EPYC 7543P 2.8GHz 32-core 225W Processor for HPE

P38717-B21

Notes:

- This processor doesn't include a fan kit or a heat sink kit.
- This processor needs selection of 3 q'ty of Standard Fan Kit (P37042-B21)
- Processors with greater than or equal to 180W will need the High Performance Heat Sink Kit (P38655-B21)

AMD EPYC 7513 2.6GHz 32-core 200W Processor for HPE

P38684-B21

Notes:

- This processor doesn't include a fan kit or a heat sink kit.
- This processor needs selection of 3 q'ty of Standard Fan Kit (P37042-B21)
- Processors with greater than or equal to 180W will need the High Performance Heat Sink Kit (P38655-B21)

AMD EPYC 7453 2.75GHz 28-core 225W Processor for HPE

P38678-B21

Notes:

- This processor doesn't include a fan kit or a heat sink kit.
- This processor needs selection of 3 q'ty of Standard Fan Kit (P37042-B21)
- Processors with greater than or equal to 180W will need the High Performance Heat Sink Kit (P38655-B21)

AMD EPYC 74F3 3.2GHz 24-core 240W Processor for HPE

P38705-B21

Notes:

- This processor doesn't include a fan kit or a heat sink kit.
- This processor needs selection of 3 q'ty of Standard Fan Kit (P37042-B21)
- Processors with greater than or equal to 180W will need the High Performance Heat Sink Kit (P38655-B21)

AMD EPYC 7443P 2.85GHz 24-core 200W Processor for HPE

P38714-B21

Notes:

- This processor doesn't include a fan kit or a heat sink kit.
- This processor needs selection of 3 q'ty of Standard Fan Kit (P37042-B21)
- Processors with greater than or equal to 180W will need the High Performance Heat Sink Kit (P38655-B21)

AMD EPYC 7413 2.65GHz 24-core 180W Processor for HPE

P38675-B21

Notes:

- This processor doesn't include a fan kit or a heat sink kit.
- This processor needs selection of 3 q'ty of Standard Fan Kit (P37042-B21)
- Processors with greater than or equal to 180W will need the High Performance Heat Sink Kit (P38655-B21)

AMD EPYC 73F3 3.5GHz 16-core 240W Processor for HPE

P38702-B21

Notes:

- This processor doesn't include a fan kit or a heat sink kit.
- This processor needs selection of 3 q'ty of Standard Fan Kit (P37042-B21)
- Processors with greater than or equal to 180W will need the High Performance Heat Sink Kit (P38655-B21)

AMD EPYC 7343 3.2GHz 16-core 190W Processor for HPE

P38672-B21

Notes:

- This processor doesn't include a fan kit or a heat sink kit.
- This processor needs selection of 3 q'ty of Standard Fan Kit (P37042-B21)



Core Options

- Processors with greater than or equal to 180W will need the High Performance Heat Sink Kit (P38655-B21)

AMD EPYC 7313P 3.0GHz 16-core 155W Processor for HPE

P38711-B21

Notes:

- This processor doesn't include a fan kit or a heat sink kit.
- This processor needs selection of 3 q'ty of Standard Fan Kit (P37042-B21)
- This processor needs selection of a Standard Heat Sink Kit (P38656-B21)

AMD EPYC 72F3 3.7GHz 8-core 180W Processor for HPE

P38699-B21

Notes:

- This processor doesn't include a fan kit or a heat sink kit.
- This processor needs selection of 3 q'ty of Standard Fan Kit (P37042-B21)
- Processors with greater than or equal to 180W will need the High Performance Heat Sink Kit (P38655-B21)

AMD EPYC 2nd Generation Processors

AMD EPYC 7502P 2.5GHz 32-core 180W Processor Kit for HPE

P39735-B21

Notes:

- This processor doesn't include a fan kit or a heat sink kit.
- This processor needs selection of 3 q'ty of Standard Fan Kit (P37042-B21)
- Processors with greater than or equal to 180W will need the High Performance Heat Sink Kit (P38655-B21)

AMD EPYC 7302P 3.0GHz 16-core 155W Processor Kit for HPE

P39737-B21

Notes:

- This processor doesn't include a fan kit or a heat sink kit.
- This processor needs selection of 3 q'ty of Standard Fan Kit (P37042-B21)
- This processor needs selection of a Standard Heat Sink Kit (P38656-B21)

AMD EPYC 7232P 3.1GHz 8-core 120W Processor Kit for HPE

P39738-B21

Notes:

- This processor doesn't include a fan kit or a heat sink kit.
- This processor needs selection of 3 q'ty of Standard Fan Kit (P37042-B21)
- This processor needs selection of a Standard Heat Sink Kit (P38656-B21)

Memory Selection

To streamline the configuration process for HPE ProLiant Gen10 Plus servers and to provide the best product availability, Hewlett Packard Enterprise recommends memory from the list located here: <http://hpe.com/products/recommend>.

Best product availability is limited to US, Canada, and Latin America at this time.

HPE Memory

Registered DIMMs (RDIMMs)

HPE 8GB (1x8GB) Single Rank x8 DDR4-3200 CAS-22-22-22 Registered Smart Memory Kit

P07638-B21

HPE 16GB (1x16GB) Single Rank x4 DDR4-3200 CAS-22-22-22 Registered Smart Memory Kit.

P07640-B21

HPE 16GB (1x16GB) Dual Rank x8 DDR4-3200 CAS-22-22-22 Registered Smart Memory Kit

P07642-B21

HPE 32GB (1x32GB) Single Rank x4 DDR4-3200 CAS-22-22-22 Registered Memory Kit

P38454-B21

HPE 32GB (1x32GB) Dual Rank x4 DDR4-3200 CAS-22-22-22 Registered Smart Memory Kit

P07646-B21

HPE 64GB (1x64GB) Dual Rank x4 DDR4-3200 CAS-22-22-22 Registered Smart Memory Kit

P07650-B21



Core Options

Load Reduced DIMMs (LRDIMMs)

HPE 128GB (1x128GB) Quad Rank x4 DDR4-3200 CAS-22-22-22 Load Reduced Smart Memory Kit	P07652-B21
HPE 256GB (1x256GB) Octal Rank x4 DDR4-3200 CAS-26-22-22 Load Reduced 3DS Smart Memory Kit	P07654-B21

256GB DIMM Support Ambient Temperature Limitations

System Config	Ambient Temp. Limitation
12LFF	Not supportable with 12LFF
8LFF	30C
24SFF/16SFF/16NVMe	30C
8SFF/ 8NVMe	35C
24NVMe	25C

Notes:

- Memory DIMM availability with a server platform is dependent upon completion of certification testing.
- The maximum memory speed is a function of the memory type, memory configuration, and processor model.
- Mixing of x4 & x8 memory is not allowed
- 8GB~128GB memory SKUs can run the transfer rate of 3200 MT/s at both 1 DIMM and 2 DIMM per channel
- 256GB memory SKU can run the transfer rate of 3200 MT/s at 1 DIMM per channel, but only 2933 MT/s at 2 DIMM per channel
- Rome processors can only support 2933 MT/s at 2 DIMM per channel
- Memory compatibility may vary or be limited within a specific server family depending upon the specific configuration being requested. Because each server environment and requirements can vary, memory compatibility is based not only upon the server family, but may also be affected by the amount and type of additional hardware options installed within a specific server configuration. For this reason, some HPE memory DIMMs may be qualified for a server model or family and yet occasionally not be supported with limited configurations within that server family. Please consult with the HPE server Quickspecs or your HPE representative if you have any questions regarding memory compatibility with a specific HPE server configuration.

HPE Optical Drives

HPE DL325 Gen10 Plus 8SFF Optical Disk Drive SATA/M.2 Enablement Kit	P20423-B21
--	------------

Notes: This kit must be selected only if HPE Universal SATA HH M.2 Kit (878783-B21) is selected.

HPE Mobile USB DVD-RW Optical Drive	701498-B21
-------------------------------------	------------

HPE Drives

Enterprise - 12G SAS – SFF/LFF Drives

HPE 300GB SAS 12G Mission Critical 15K SFF BC 3-year Warranty Multi Vendor HDD	P28028-B21
HPE 300GB SAS 12G Mission Critical 10K SFF BC 3-year Warranty Multi Vendor HDD	P40430-B21
HPE 600GB SAS 12G Mission Critical 15K SFF BC 3-year Warranty Multi Vendor HDD	P53560-B21
HPE 600GB SAS 12G Mission Critical 10K SFF BC 3-year Warranty Multi Vendor HDD	P53561-B21
HPE 900GB SAS 12G Mission Critical 15K SFF BC 3-year Warranty Multi Vendor HDD	P40432-B21
HPE 1.2TB SAS 12G Mission Critical 10K SFF BC 3-year Warranty Multi Vendor HDD	P28586-B21
HPE 2.4TB SAS 12G Mission Critical 10K SFF BC 3-year Warranty 512e Multi Vendor HDD	P28352-B21
HPE 1.8TB SAS 12G Mission Critical 10K SFF BC 3-year Warranty 512e Multi Vendor HDD	P53562-B21

Midline - 12G SAS - SFF Drives

HPE 2TB SAS 12G Business Critical 7.2K SFF BC 1-year Warranty 512e HDD	P28505-B21
HPE 1TB SAS 12G Business Critical 7.2K SFF BC 1-year Warranty HDD	P53563-B21

Midline - 12G SAS - LFF Drives

HPE 2TB SAS 12G Business Critical 7.2K LFF LP 1-year Warranty Multi Vendor HDD	833926-B21
HPE 4TB SAS 12G Business Critical 7.2K LFF LP 1-year Warranty Multi Vendor HDD	833928-B21
HPE 6TB SAS 12G Business Critical 7.2K LFF LP 1-year Warranty 512e Multi Vendor HDD	861746-B21
HPE 8TB SAS 12G Business Critical 7.2K LFF LP 1-year Warranty 512e Multi Vendor HDD	834031-B21
HPE 10TB SAS 12G Business Critical 7.2K LFF LP 1-year Warranty 512e ISE Multi Vendor HDD	P53556-B21



Core Options

HPE 12TB SAS 12G Business Critical 7.2K LFF LP 1-year Warranty Helium 512e Multi Vendor HDD	881781-B21
HPE 14TB SAS 12G Business Critical 7.2K LFF LP 1-year Warranty Helium 512e Multi Vendor HDD	P09155-B21
HPE 16TB SAS 12G Business Critical 7.2K LFF LP 1-year Warranty Helium 512e ISE Multi Vendor HDD	P23608-B21
HPE 18TB SAS 12G Business Critical 7.2K LFF LP 1-year Warranty Helium 512e ISE Multi Vendor HDD	P37669-B21
HPE 20TB SAS 12G Business Critical 7.2K LFF LP 1-year Warranty Helium 512e ISE Multi Vendor HDD	P53553-B21

Midline - 6G SATA - SFF Drives

HPE 1TB SATA 6G Business Critical 7.2K SFF BC 1-year Warranty HDD	P28610-B21
HPE 2TB SATA 6G Business Critical 7.2K SFF BC 1-year Warranty 512e HDD	P28500-B21

Midline - 6G SATA - LFF Drives

HPE 1TB SATA 6G Business Critical 7.2K LFF LP 1-year Warranty Multi Vendor HDD	861686-B21
HPE 2TB SATA 6G Business Critical 7.2K LFF LP 1-year Warranty Multi Vendor HDD	861681-B21
HPE 4TB SATA 6G Business Critical 7.2K LFF LP 1-year Warranty Multi Vendor HDD	861683-B21
HPE 6TB SATA 6G Business Critical 7.2K LFF LP 1-year Warranty 512e Multi Vendor HDD	861742-B21
HPE 8TB SATA 6G Business Critical 7.2K LFF LP 1-year Warranty 512e Multi Vendor HDD	834028-B21
HPE 10TB SATA 6G Business Critical 7.2K LFF LP 1-year Warranty 512e ISE Multi Vendor HDD	P53557-B21
HPE 12TB SATA 6G Business Critical 7.2K LFF LP 1-year Warranty Helium 512e Multi Vendor HDD	881787-B21
HPE 14TB SATA 6G Business Critical 7.2K LFF LP 1-year Warranty Helium 512e Multi Vendor HDD	P09165-B21
HPE 16TB SATA 6G Business Critical 7.2K LFF LP 1-year Warranty Helium 512e ISE Multi Vendor HDD	P23449-B21
HPE 18TB SATA 6G Business Critical 7.2K LFF LP 1-year Warranty Helium 512e ISE Multi Vendor HDD	P37678-B21
HPE 20TB SATA 6G Business Critical 7.2K LFF LP 1-year Warranty Helium 512e ISE Multi Vendor HDD	P53554-B21

SED (Self-Encryption Drive) Hard Drives

HPE 2.4TB SAS 12G Mission Critical 10K SFF BC 3-year Warranty 512e Self-encrypting FIPS HDD	P28618-B21
HPE 1.2TB SAS 12G Mission Critical 10K SFF BC 3-year Warranty Self-encrypting FIPS HDD	P28622-B21

Notes: Requirements for MR Tri-mode controller SED support

- TPM is not required for Local Key Management as key is stored in controller
- iLO Advanced is required for Remote Key Management. Key is stored in remote key manager (Ex. ESKM)

SSD Selection

To streamline the configuration process for HPE ProLiant Gen10 Plus servers and to provide the best product availability, HPE recommends SSDs from the list located here: <http://www.hpe.com/products/recommend>.

Read Intensive - 12G SAS - SFF - Solid State Drives

HPE 960GB SAS 24G Read Intensive SFF BC Multi Vendor SSD	P49029-B21
HPE 960GB SAS 12G Read Intensive SFF BC Value SAS Multi Vendor SSD	P40506-B21
HPE 1.92TB SAS 24G Read Intensive SFF BC Multi Vendor SSD	P49031-B21
HPE 1.92TB SAS 12G Read Intensive SFF BC Value SAS Multi Vendor SSD	P40507-B21
HPE 3.84TB SAS 24G Read Intensive SFF BC Multi Vendor SSD	P49035-B21
HPE 3.84TB SAS 12G Read Intensive SFF BC Value SAS Multi Vendor SSD	P40508-B21
HPE 7.68TB SAS 24G Read Intensive SFF BC Multi Vendor SSD	P49041-B21
HPE 7.68TB SAS 12G Read Intensive SFF BC Value SAS Multi Vendor SSD	P40509-B21
HPE 15.36TB SAS 24G Read Intensive SFF BC Multi Vendor SSD	P49045-B21

Read Intensive - 12G SAS - LFF - Solid State Drives

HPE 7.68TB SAS 24G Read Intensive LFF LPC Multi Vendor SSD	P49040-B21
--	------------

Mixed Use - 12G SAS - SFF - Solid State Drives

HPE 800GB SAS 24G Mixed Use SFF BC Multi Vendor SSD	P49047-B21
HPE 960GB SAS 12G Mixed Use SFF BC Value SAS Multi Vendor SSD	P40510-B21
HPE 1.6TB SAS 24G Mixed Use SFF BC Multi Vendor SSD	P49049-B21
HPE 1.92TB SAS 12G Mixed Use SFF BC Value SAS Multi Vendor SSD	P40511-B21
HPE 3.2TB SAS 24G Mixed Use SFF BC Multi Vendor SSD	P49053-B21



Core Options

HPE 3.84TB SAS 12G Mixed Use SFF BC Value SAS Multi Vendor SSD	P40512-B21
HPE 6.4TB SAS 24G Mixed Use SFF BC Multi Vendor SSD	P49057-B21
Mixed Use SAS- LFF- Solid State Drives	
HPE 960GB SAS 12G Mixed Use LFF LPC Value SAS Multi Vendor SSD	P37009-B21
Mixed Use - 6G SATA - SFF - Solid State Drives	
HPE 480GB SATA 6G Mixed Use SFF BC PM897 SSD	P44011-B21
HPE 480GB SATA 6G Mixed Use SFF BC Multi Vendor SSD	P40502-B21
HPE 960GB SATA 6G Mixed Use SFF BC PM897 SSD	P44012-B21
HPE 960GB SATA 6G Mixed Use SFF BC Multi Vendor SSD	P40503-B21
HPE 1.92TB SATA 6G Mixed Use SFF BC PM897 SSD	P44013-B21
HPE 1.92TB SATA 6G Mixed Use SFF BC Multi Vendor SSD	P40504-B21
HPE 3.84TB SATA 6G Mixed Use SFF BC Multi Vendor SSD	P40505-B21
Read Intensive - 6G SATA - SFF - Solid State Drives	
HPE 240GB SATA 6G Read Intensive SFF BC Multi Vendor SSD	P40496-B21
HPE 480GB SATA 6G Read Intensive SFF BC PM893 SSD	P44007-B21
HPE 480GB SATA 6G Read Intensive SFF BC Multi Vendor SSD	P40497-B21
HPE 960GB SATA 6G Read Intensive SFF BC PM893 SSD	P44008-B21
HPE 960GB SATA 6G Read Intensive SFF BC Multi Vendor SSD	P40498-B21
HPE 1.92TB SATA 6G Read Intensive SFF BC PM893 SSD	P44009-B21
HPE 1.92TB SATA 6G Read Intensive SFF BC Multi Vendor SSD	P40499-B21
HPE 3.84TB SATA 6G Read Intensive SFF BC PM893 SSD	P44010-B21
HPE 3.84TB SATA 6G Read Intensive SFF BC Multi Vendor SSD	P40500-B21
HPE 7.68TB SATA 6G Read Intensive SFF BC Multi Vendor SSD	P40501-B21
6G SATA - LFF - Solid State Drives	
HPE 960GB SATA 6G Read Intensive LFF LPC Multi Vendor SSD	P47808-B21
HPE 7.68TB SATA 6G Very Read Optimized LFF LPC 5400 SSD	P58232-B21
VRO - 6G SATA - SFF - Solid State Drives	
HPE 7.68TB SATA 6G Very Read Optimized SFF BC 5400 SSD	P58228-B21
Write Intensive - NVMe - SFF - Solid State Drives	
Read Intensive - NVMe - SFF - Solid State Drives	
HPE 960GB NVMe Gen4 Mainstream Performance Read Intensive SFF BC U.3 Static Multi Vendor SSD	P47844-B21
HPE 1.92TB NVMe Gen4 High Performance Read Intensive SFF BC U.3 PM1733a SSD	P50216-B21
HPE 1.92TB NVMe Gen4 High Performance Read Intensive SFF BC U.2 P5520 SSD	P51453-B21
HPE 1.9TB NVMe Gen4 Mainstream Performance Read Intensive SFF BC U.3 Static Multi Vendor SSD	P47845-B21
HPE 3.84TB NVMe Gen4 High Performance Read Intensive SFF BC U.3 PM1733a SSD	P50219-B21
HPE 3.84TB NVMe Gen4 High Performance Read Intensive SFF BC U.2 P5520 SSD	P51455-B21
HPE 3.84TB NVMe Gen4 Mainstream Performance Read Intensive SFF BC U.3 Static Multi Vendor SSD	P47846-B21
HPE 7.68TB NVMe Gen4 High Performance Read Intensive SFF BC U.3 PM1733a SSD	P50222-B21
HPE 7.68TB NVMe Gen4 High Performance Read Intensive SFF BC U.2 P5520 SSD	P51457-B21
HPE 7.68TB NVMe Gen4 Mainstream Performance Read Intensive SFF BC U.3 Static Multi Vendor SSD	P47847-B21
HPE 15.36TB NVMe Gen4 High Performance Read Intensive SFF BC U.3 PM1733a SSD	P50224-B21
Mixed Use - NVMe - SFF - Solid State Drives	
HPE 800GB NVMe Gen4 Mainstream Performance Mixed Use SFF BC U.3 Static Multi Vendor SSD	P47837-B21
HPE 1.6TB NVMe Gen4 High Performance Mixed Use SFF BC U.3 PM1735a SSD	P50227-B21
HPE 1.6TB NVMe Gen4 High Performance Mixed Use SFF BC U.2 P5520 SSD	P51459-B21
HPE 1.6TB NVMe Gen4 Mainstream Performance Mixed Use SFF BC U.3 Static Multi Vendor SSD	P47838-B21
HPE 3.2TB NVMe Gen4 High Performance Mixed Use SFF BC U.3 PM1735a SSD	P50230-B21



Core Options

HPE 3.2TB NVMe Gen4 High Performance Mixed Use SFF BC U.2 P5620 SSD	P51461-B21
HPE 3.2TB NVMe Gen4 Mainstream Performance Mixed Use SFF BC U.3 Static Multi Vendor SSD	P47839-B21
HPE 6.4TB NVMe Gen4 High Performance Mixed Use SFF BC U.3 PM1735a SSD	P50233-B21
HPE 6.4TB NVMe Gen4 High Performance Mixed Use SFF BC U.2 P5620 SSD	P51463-B21
HPE 6.4TB NVMe Gen4 Mainstream Performance Mixed Use SFF BC U.3 Static Multi Vendor SSD	P47840-B21

SED (Self-Encryption Drive)

HPE 800GB SAS 24G Mixed Use SFF BC Self-encrypting FIPS PM6 SSD	P41400-B21
HPE 1.6TB SAS 24G Mixed Use SFF BC Self-encrypting FIPS PM6 SSD	P41401-B21
HPE 960GB SATA 6G Mixed Use SFF BC Self-encrypting 5400M SSD	P58244-B21
HPE 480GB SATA 6G Read Intensive SFF BC Self-encrypting 5400P SSD	P58236-B21
HPE 3.84TB SAS 24G Read Intensive SFF BC Self-encrypting FIPS PM6 SSD	P41398-B21
HPE 7.68TB SAS 24G Read Intensive SFF BC Self-encrypting FIPS PM6 SSD	P41399-B21
HPE 1.6TB NVMe Gen4 High Performance Mixed Use SFF BC Self-encrypting FIPS U.3 CM6 SSD	P41404-B21
HPE 3.2TB NVMe Gen4 High Performance Mixed Use SFF BC Self-encrypting FIPS U.3 CM6 SSD	P41405-B21
HPE 1.92TB NVMe Gen4 High Performance Read Intensive SFF BC Self-encrypting FIPS U.3 CM6 SSD	P41402-B21
HPE 3.84TB NVMe Gen4 High Performance Read Intensive SFF BC Self-encrypting FIPS U.3 CM6 SSD	P41403-B21
HPE 1.92TB SATA 6G Mixed Use SFF BC Self-encrypting 5400M SSD	P58248-B21
HPE 1.92TB SATA 6G Read Intensive SFF BC Self-encrypting 5400P SSD	P58240-B21

Notes:

- Requirements for Direct Attach SED support
 - TPM2.0 is required for Local Key Management. Keys will be locally encrypted and stored by TPM
 - iLO Advanced is required for Remote Key Management. Key is stored in remote key manager (Ex. ESKM)
- Requirements for MR Tri-mode controller SED support
 - TPM is not required for Local Key Management as key is stored in controller
 - iLO Advanced is required for Remote Key Management. Key is stored in remote key manager (Ex. ESKM)

Internal Dual M.2 Kit

HPE Universal SATA 6G AIC HHHL M.2 SSD Enablement Kit	878783-B21
---	------------

Notes:

- This kit needs to be selected when M.2 SSD Drive (s) are selected. Min =1/ Max =2.
- This kit requires the selection of one HPE DL325 Gen10+ 8SFF ODD SATA/M.2 Kit (P20423-B21).
- If SATA SFF drives are selected and Embedded Controller are used to support 2SFF U.3 drive cage then this kit cannot be selected.
- This kit requires a PCIe slot and supports up to two M.2 SSDs which should be the same SSD SKUs
- M.2 SATA SSDs attached to this enablement kit do not support SR100i RAID

Read Intensive - M.2 - Solid State Drives

HPE 240GB SATA 6G Read Intensive M.2 Multi Vendor SSD	P47817-B21
HPE 480GB SATA 6G Read Intensive M.2 Multi Vendor SSD	P47818-B21

Hard Drive Blank Kits

HPE Gen9 LFF HDD Spade Blank Kit	807878-B21
HPE Small Form Factor Hard Drive Blank Kit	666987-B21

HPE Tape Backup

For the complete range of tape drives, autoloaders, libraries and media see:

<https://www.hpe.com/us/en/storage/storeever-tape-storage.html>.

For hardware and software compatibility of Hewlett Packard Enterprise tape backup products

<http://www.hpe.com/storage/BURACompatibility>



Core Options

Hard Drive Kits

HPE ProLiant DL345 Gen10 Plus 8SFF BC Box 1-2 Drive Cage Kit P38652-B21

Notes:

- This is supported only in 8SFF CTO chassis.
- This supports 8 SAS/SATA SFF Drives.
- Mixing of LFF & SFF drive cage is not allowed.
- Customer can select Min 0 or Max 1 of 8SFF Bay1/2 drive cage.

HPE ProLiant DL345 Gen10 Plus 12LFF Smart Array SAS/SATA Cable Kit P38653-B21

Notes:

- This is supported only in 8LFF CTO chassis.
- This supports 4 SAS/SATA LFF Drives.
- Mixing of LFF & SFF drive cage is not allowed.
- Customer can select Min 0, Max 1 of HPE DL345 Gen10+ 12LFF SA SAS/SATA Kit (P38653-B21)
- This option requires the selection of Max Perf Fan Kit (P14608-B21).
- If this kit is selected then P816i-a controller must be selected.

HPE ProLiant DL300 Gen10 Plus 2U 8SFF x4 Tri-Mode 24G U.3 BC Front Drive Cage Kit P26931-B21

Notes:

- Mixing of LFF & SFF drive cage is not allowed.
- This drive cage kit requires Max Performance fan kit.
- 8SFF NVMe U.3/U.2 drive cage kits can only be selected with the 8SFF CTO chassis.
- 8SFF NVMe x1 U.3 drive cage /8SFF NVMe x4 U.3 drive cage and 8SFF NVMe x4 U.2 drive cage cannot be selected together.
- 8SFF NVMe x1 U.3 drive cage and 8SFF NVMe x4 U.3 drive cage cannot be selected together.
- If 3qty of NVMe drive cage from the below list are selected then HPE 8SFF Front Remove SPEC Perf FIO (873763-B21) must be selected.
 - 8SFF NVME x1 U.3 drive cage (P27194-B21)
 - 8SFF NVME x4 U.3 drive cage (P26931-B21)
 - 8SFF NVME x4 U.2 drive cage (P26932-B21)
- If 8SFF NVMe x1 U.3 /8SFF NVMe x4 U.3 drive cage is selected along with Trimode Controller then 8SFF NVMe x1 U.3 /8SFF NVMe x4 U.3 drive cage can support SAS/SATA SFF and NVMe U.3 drives.
- If two q'ty of 8SFF NVMe x4 U.3 drive cage or 8SFF NVMe x4 U.2 cage and SR932i-p are selected then HPE DL345 Gen10+ x16 Sec Riser Kit (P38641-B21) must be selected.
- If two q'ty of 8SFF NVMe x4 U.3 drive cage or 8SFF NVMe x4 U.2 cage and MR416i-P / MR216i-P are selected then HPE DL345 Gen10+ x16 Sec Riser Kit (P38641-B21) or HPE DL345 Gen10P 2x8 SEC Rsr Kit (P38637-B21) must be selected.
- If 8SFF NVMe x1 U.3/8SFF NVMe x4 U.3 drive cage is selected along with a Tri-mode Controller then SAS/SATA/NVMe U.3 drives can be selected.
- If 8SFF NVMe x1 U.3/8SFF NVMe x4 U.3 drive cage is selected without a Tri-mode Controller then only NVMe U.3 drives can be selected.
- NVMe Direct attach will be used to support NVMe U.3 drives if TM controller is not selected.

HPE ProLiant DL300 Gen10 Plus 2U 8SFF x1 Tri-Mode 24G U.3 BC Front Drive Cage Kit P27194-B21

Notes:

- Mixing of LFF & SFF drive cage is not allowed.
- This drive cage kit requires Max Performance fan kit.
- 8SFF NVMe U.3/U.2 drive cage kits can only be selected with the 8SFF CTO chassis.
- 8SFF NVMe x1 U.3 drive cage /8SFF NVMe x4 U.3 drive cage and 8SFF NVMe x4 U.2 drive cage cannot be selected together.
- 8SFF NVMe x1 U.3 drive cage and 8SFF NVMe x4 U.3 drive cage cannot be selected together.
- If 3qty of NVMe drive cage from the below list are selected then HPE 8SFF Front Remove SPEC Perf FIO (873763-B21) must be selected.



Core Options

- 8SFF NVME x1 U.3 drive cage (P27194-B21)
- 8SFF NVME x4 U.3 drive cage (P26931-B21)
- 8SFF NVME x4 U.2 drive cage (P26932-B21)
- If 8SFF NVME x1 U.3 /8SFF NVME x4 U.3 drive cage is selected along with Tri-mode Controller then 8SFF NVME x1 U.3 /8SFF NVME x4 U.3 drive cage can support SAS/SATA SFF and NVMe U.3 drives.
- Tri-mode AROC controller can be selected only with 8SFF NVME x1 U.3 drive cage (P27194-B21).
- If 8SFF NVME x1 U.3 drive cage (P27194-B21) is selected then tri-mode controller must be selected.
- If 8SFF NVMe x1 U.3/8SFF NVMe x4 U.3 drive cage is selected along with a Tri-mode Controller then SAS/SATA/NVMe U.3 drives can be selected.
- If 8SFF NVMe x1 U.3/8SFF NVMe x4 U.3 drive cage is selected without a Tri-mode Controller then only NVMe U.3 drives can be selected.
- NVMe Direct attach will be used to support NVMe U.3 drives if TM controller is not selected.

HPE ProLiant DL300 Gen10 Plus 2U 8SFF x4 NVMe 16G U.2 BC Front Drive Cage Kit

P26932-B21

Notes:

- Mixing of LFF & SFF drive cage is not allowed.
- This drive cage kit requires Max Performance fan kit.
- 8SFF NVMe U.3/U.2 drive cage kits can only be selected with the 8SFF CTO chassis.
- 8SFF NVMe x1 U.3 drive cage /8SFF NVMe x4 U.3 drive cage and 8SFF NVMe x4 U.2 drive cage cannot be selected together.
- If 3qty of NVMe drive cage from the below list are selected then HPE 8SFF Front Remove SPEC Perf FIO (873763-B21) must be selected.
 - 8SFF NVME x1 U.3 drive cage (P27194-B21)
 - 8SFF NVME x4 U.3 drive cage (P26931-B21)
 - 8SFF NVME x4 U.2 drive cage (P26932-B21)
- If 8SFF NVMe x4 U.2 drive cage and 2SFF U.3 drive cage are selected together then 2SFF U.3 drive cage can support only SAS/SATA SFF drives.
- If two q'ty of 8SFF NVMe x4 U.3 drive cage or 8SFF NVMe x4 U.2 cage and SR932i-p are selected then HPE DL345 Gen10+ x16 Sec Riser Kit (P38641-B21) must be selected.
- If two q'ty of 8SFF NVMe x4 U.3 drive cage or 8SFF NVMe x4 U.2 cage and MR416i-P / MR216i-P are selected then HPE DL345 Gen10+ x16 Sec Riser Kit (P38641-B21) or HPE DL345 Gen10P 2x8 SEC Rsr Kit (P38637-B21) must be selected.
- If 8SFF NVMe x4 U.2 drive cage is selected then only NVMe U.3 / NVMe U.2 drives can be selected.

HPE ProLiant DL345 Gen10 Plus 2SFF U.3 BC Front/Rear Backplane Kit

P38654-B21

Notes:

- This kit supports 2x NVMe U.3/SAS/SATA drives in rear.
- Customer can select Min 0, Max 1 of 2SFF U.3 Drive cage (P38654-B21).
- If 8SFF NVMe x4 U.2 drive cage and 2SFF U.3 drive cage are selected together then 2SFF U.3 drive cage can support only SAS/SATA SFF drives.
- This option requires the selection of Max Perf Fan Kit (P14608-B21).

HPE ProLiant DL38x Gen10 Plus 8SFF SAS/SATA to Tri-Mode Controller Backplane Kit

P55516-B21

Notes: This kit supports 8x NVMe U.3/SAS/SATA drives.

HPE ProLiant DL345 Gen10 Plus 12LFF SAS/SATA Tri-Mode Backplane Kit

P57819-B21

Notes:

- This kit supports 4x SAS/SATA drives.
- Requires 8LFF CTO server in the order, to support 12 LFF at the front with MR(MegaRAID) controllers.

HPE Storage Options

Emulex Fibre Channel HBAs

HPE SN1200E 16Gb Single Port Fibre Channel Host Bus Adapter

Q0L13A

HPE SN1200E 16Gb Dual Port Fibre Channel Host Bus Adapter

Q0L14A



Core Options

HPE SN1610E 32Gb 1-port Fibre Channel Host Bus Adapter	R2J62A
HPE SN1610E 32Gb 2-port Fibre Channel Host Bus Adapter	R2J63A
HPE SN1700E 64Gb 1-port Fibre Channel Host Bus Adapter	R7N77A
HPE SN1700E 64Gb 2-port Fibre Channel Host Bus Adapter	R7N78A
QLogic Fibre Channel HBAs	
HPE SN1100Q 16Gb Single Port Fibre Channel Host Bus Adapter	P9D93A
HPE SN1100Q 16Gb Dual Port Fibre Channel Host Bus Adapter	P9D94A
HPE SN1610Q 32Gb 1-port Fibre Channel Host Bus Adapter	R2E08A
HPE SN1610Q 32Gb 2-port Fibre Channel Host Bus Adapter	R2E09A
Storage Offload Adapter	
HPE NV60100M 100Gb 2-port Storage Offload Adapter	R8M41A

HPE Smart IO

Requirements:

- One 3yr/4yr/5yr Silver or 3yr/4yr/5yr Platinum license must be purchased for every DSC-25 card in a server.
- 1yr Silver, 1yr Platinum, and 1yr Policy and Services Manager (PSM) licenses are reserved for renewals only.
- One Policy and Services Manager (PSM) license is required to manage up to 3,000 DSC-25 cards.

Pensando Distributed Services Card (DSC)

Pensando Distributed Services Platform DSC-25 Enterprise 10/25Gb 2-port SFP28 Card	P26966-B21
--	------------

Notes: Each card instance requires one RTU license of Silver or Platinum software. In case of more than one adapter, RTU licenses doesn't need to be of the same part number.

Pensando DSP Silver Software Licenses

Pensando Distributed Services Platform Enterprise 1-year Renewal Subscription 24x7 Support E-RTU	R6A06AAE
Pensando Distributed Services Platform Enterprise 3-year Subscription 24x7 Support E-RTU	R6A07AAE
Pensando Distributed Services Platform Enterprise 4-year Subscription 24x7 Support E-RTU	R6F68AAE
Pensando Distributed Services Platform Enterprise 5-year Subscription 24x7 Support E-RTU	R6A08AAE

Pensando DSP Platinum Software Licenses

Pensando Distributed Services Platform Enterprise Pro 1-year Renewal Subscription 24x7 Support E-RTU	R6A09AAE
Pensando Distributed Services Platform Enterprise Pro 3-year Subscription 24x7 Support E-RTU	R6A10AAE
Pensando Distributed Services Platform Enterprise Pro 4-year Subscription 24x7 Support E-RTU	R6F69AAE
Pensando Distributed Services Platform Enterprise Pro 5-year Subscription 24x7 Support E-RTU	R6A11AAE

HPE Networking

1 Gigabit Ethernet adapters

Intel I350-T4 Ethernet 1Gb 4-port BASE-T Adapter for HPE	P21106-B21
Broadcom BCM5719 Ethernet 1Gb 4-port BASE-T Adapter for HPE	P51178-B21

10 Gigabit Ethernet adapters

Marvell QL41132HLRJ Ethernet 10Gb 2-port BASE-T Adapter for HPE	P08437-B21
Marvell QL41132HLCU Ethernet 10Gb 2-port SFP+ Adapter for HPE	P21933-B21
Marvell QL41134HLCU Ethernet 10Gb 4-port SFP+ Adapter for HPE	P10094-B21
Broadcom BCM57416 Ethernet 10Gb 2-port BASE-T Adapter for HPE	P26253-B21
Broadcom BCM57412 Ethernet 10Gb 2-port SFP+ Adapter for HPE	P26259-B21
Intel X710-DA2 Ethernet 10Gb 2-port SFP+ Adapter for HPE	P28787-B21

10/25 Gigabit Ethernet adapters

Mellanox MCX512F-ACHT Ethernet 10/25Gb 2-port SFP28 Adapter for HPE	P13188-B21
Mellanox MCX631102AS-ADAT Ethernet 10/25Gb 2-port SFP28 Adapter for HPE	P42044-B21
Xilinx X2522-25G-PLUS Ethernet 10/25Gb 2-port SFP28 Adapter for HPE	P21109-B21
Marvell QL41232HLCU Ethernet 10/25Gb 2-port SFP28 Adapter for HPE	P22702-B21



Core Options

Broadcom BCM57414 Ethernet 10/25Gb 2-port SFP28 Adapter for HPE P26262-B21

100/200 Gigabit Ethernet adapters

Intel E810-CQDA2 Ethernet 100Gb 2-port QSFP28 Adapter for HPE P21112-B21

HPE Ethernet 100Gb 1-port QSFP28 PCIe3 x16 MCX515A-CCAT Adapter P31246-B21

Mellanox MCX623106AS-CDAT Ethernet 100Gb 2-port QSFP56 Adapter for HPE P25960-B21

Mellanox MCX623105AS-VDAT Ethernet 200Gb 1-port QSFP56 Adapter for HPE P10180-B21

Notes:

- Above 100/200 Gb cards require the selection of Max Perf Fan Kit (P14608-B21). Except for P21112-B21. P21112-B21 doesn't need a Max Perf Fan Kit and no ambient temp. restrictions.
- Customer must select HPE DL345 Gen10P x16 Secondary Riser Kit (P38641-B21), if more than two x16 PCIe cards are selected.
- A minimum of two Gigabytes (2 GB) of server memory is required per each adapter.
- Direct Attach Cable (DAC) for copper environments or fiber transceivers and cables for fiber-optic environments must be purchased separately. Please see the related NIC QuickSpecs for Technical Specifications and additional information:

<https://h20195.www2.hpe.com/v2/getpdf.aspx/A00002507ENW.pdf?>

Recommended System Ambient Temperature

System Config	P10180-B21	P25960-B21	P31246-B21
12LFF	25C	25C	25C
8LFF	30C	30C	30C
24SFF	30C	30C	30C
16SFF/ 8SFF	35C	35C	35C
24NVMe/ 16NVMe	30C	30C	30C
8NVMe	35C	35C	35C

Other Restrictions

- Required to use Max Performance Fan Kit

OCP Adapters

Intel I350-T4 Ethernet 1Gb 4-port BASE-T OCP3 Adapter for HPE P08449-B21

Broadcom BCM5719 Ethernet 1Gb 4-port BASE-T OCP3 Adapter for HPE P51181-B21

Marvell QL41132HQCU Ethernet 10Gb 2-port SFP+ OCP3 Adapter for HPE P08452-B21

Marvell QL41132HQRJ Ethernet 10Gb 2-port BASE-T OCP3 Adapter for HPE P10103-B21

Broadcom BCM57416 Ethernet 10Gb 2-port BASE-T OCP3 Adapter for HPE P10097-B21

Broadcom BCM57412 Ethernet 10Gb 2-port SFP+ OCP3 Adapter for HPE P26256-B21

Intel X710-DA2 Ethernet 10Gb 2-port SFP+ OCP3 Adapter for HPE P28778-B21

Broadcom BCM57414 Ethernet 10/25Gb 2-port SFP28 OCP3 Adapter for HPE P10115-B21

Mellanox MCX562A-ACAI Ethernet 10/25Gb 2-port SFP28 OCP3 Adapter for HPE P10112-B21

Mellanox MCX631432AS-ADAI Ethernet 10/25Gb 2-port SFP28 OCP3 Adapter for HPE P42041-B21

Marvell QL41232HQCU Ethernet 10/25Gb 2-port SFP28 OCP3 Adapter for HPE P10118-B21

Notes:

- OCP adapters do not consume PCIe slot.
- Only 1 slot is available for OCP adapters.
- Only SFF OCP adapters below 35W can be supported



Core Options

HPE InfiniBand

HPE InfiniBand HDR/Ethernet 200Gb 1-port QSFP56 PCIe4 x16 OCP3 MCX653435A-HDAI Adapter	P31323-B21
HPE InfiniBand HDR/Ethernet 200Gb 2-port QSFP56 PCIe4 x16 OCP3 MCX653436A-HDAI Adapter	P31348-B21
HPE InfiniBand HDR/Ethernet 200Gb 2-port QSFP56 PCIe4 x16 MCX653106A-HDAT Adapter	P31324-B21
HPE InfiniBand HDR/Ethernet 200Gb 1-port QSFP56 PCIe4 x16 MCX653105A-HDAT Adapter	P23664-B21
HPE InfiniBand HDR100/Ethernet 100Gb 1-port QSFP56 PCIe4 x16 MCX653105A-ECAT Adapter	P23665-B21
HPE InfiniBand HDR100/Ethernet 100Gb 2-port QSFP56 PCIe4 x16 MCX653106A-ECAT Adapter	P23666-B21

Notes: Max Performance Fan Kit (P14608-B21) is required to support InfiniBand cards. No ambient temperature limitation.

Recommended System Ambient Temperature

System Config	For all of the above InfiniBand 100Gb/200Gb Ethernet Adapters
12LFF	25C
8LFF	30C
24SFF	30C
16SFF/ 8SFF	35C
24NVMe/ 16NVMe	30C
8NVMe	35C

Notes: When supported with AOC (Active Optical Cables), ambient temperature will follow below restrictions:

Recommended System Ambient Temperature

System Config	For all of the above InfiniBand 100Gb/200Gb Ethernet Adapters
12LFF	22C
8LFF	27C
24SFF	27C
16SFF/ 8SFF	32C
24NVMe/ 16NVMe	27C
8NVMe	32C

Notes:

- The AOC cables are:
 - o P28169-B21 HPE IB HDR 200Gb QSFP56 3m AOC
 - o P28169-B22 HPE IB HDR 200Gb QSFP56 5m AOC
 - o P28169-B23 HPE IB HDR 200Gb QSFP56 10m AOC
 - o P28169-B24 HPE IB HDR 200Gb QSFP56 15m AOC
 - o P28169-B25 HPE IB HDR 200Gb QSFP56 20m AOC
 - o P28169-B26 HPE IB HDR 200Gb QSFP56 30m AOC

HPE Graphic Options

HPE Computation and Graphics Accelerator

Part number	Card	Q'ty per Server	Max Ambient Temperature					24NVMe	16NVMe/ 8NVMe
			12LFF	8LFF	24SFF	16SFF/8SFF			
R4B02C	Xilinx Alveo U50 Accelerator for HPE	3	20C	25C	25C	30C	Not Support	25C	
R9W59C	Nvidia A10 Graphics Accelerator for HPE	3	20C	25C	25C	30C	Not Support	25C	



Core Options

Xilinx Alveo U50 Accelerator for HPE

R4B02C

Notes:

- This is a single wide, HH/HL GPU card.
- This option requires the selection of Max Perf Fan Kit (P14608-B21).
- Customer must select HPE DL345 Gen10P x16 Secondary Riser Kit (P38641-B21), if more than two U50 cards are selected.
- This card cannot be supported under below scenarios:
 - o 3 Q'ty of 8SFF NVMe x1 U.3 drive cage is in use
 - o 3 Q'ty of 8SFF NVMe x4 U.3 drive cage is in use
 - o 3 Q'ty of 8SFF NVMe x4 U.2 drive cage is in use

NVIDIA A10 24GB PCIe Non-CEC Accelerator for HPE

R9W59C

Notes: Require cable kit (P38664-B21) in the order

HPE ProLiant DL345 Gen10 Plus GPU Power Cable Kit

P38663-B21

Notes:This cable kit is required when Nvidia A10 graphics accelerator is selected

HPE Cooling Options

HPE ProLiant DL345 Gen10 Plus Standard Heat Sink Kit

P38656-B21

Notes:

- Heatsink is not included in the processor kit. Need to be selected separately
- Must be selected if processor is less than 180W

HPE ProLiant DL345 Gen10 Plus High Performance Heat Sink Kit

P38655-B21

Notes:

- Heatsink is not included in the processor kit. Need to be selected separately
- Must be selected if processor is equal to or higher than 180W

HPE ProLiant DL300 Gen10 Plus 2U Standard Fan Kit

P37042-B21

Notes:

- 3 q'ty of Standard Fan Kit (P37042-B21) must be selected if 8LFF CTO chassis or 8SFF CTO chassis is in the order.
- Standard Fan Kit (P37042-B21) and Max Perf Fan Kit (P14608-B21) cannot be selected together

HPE DL38X Gen10 Plus Maximum Performance Fan Kit

P14608-B21

Notes:

- Maximum 1 set of Maximum Performance Fan Kit can be supported
- Max Perf Fan Kit (P14608-B21) must be selected if any of the below options is in the order
 - o AMD EPYC 7763 (280W) (P38696-B21)
 - o AMD EPYC 75F3 (280W) (P38708-B21)
 - o 12LFF AROC SAS/SAT kit (P38653-B21)
 - o 2SFF U.3 HDD Kit (P38654-B21)
 - o NVME x1 U.3 drive cage (P27194-B21)
 - o NVME x4 U.3 drive cage (P26931-B21)
 - o NVME x4 U.2 drive cage (P26932-B21)
 - o MLX MCX515A-CCAT Adapter (P31246-B21)
 - o MLX MCX623106AS 100GbE 2p QSFP56 Adptr (P25960-B21)
 - o MLX MCX623105AS 200GbE 1p QSFP56 Adptr (P10180-B21)
 - o InfiniBand Cards
 - o PCIe Accelerators
 - o Graphics cards
- Standard Fan Kit (P37042-B21) and Max Perf Fan Kit (P14608-B21) cannot be selected together



Core Options

HPE Power Supplies

HPE 500W Flex Slot Platinum Hot Plug Low Halogen Power Supply Kit 865408-B21

Notes: Flex Slot Platinum power supplies support power efficiency of up to 94% and include a standard C-14 power inlet connector.

HPE 800W Flex Slot Titanium Hot Plug Low Halogen Power Supply Kit 865438-B21

Notes: Flex Slot Titanium power supplies support power efficiency of up to 96% and include a standard C-14 power inlet connector.

HPE 800W Flex Slot Platinum Hot Plug Low Halogen Power Supply Kit P38995-B21

Notes: Flex Slot Platinum power supplies support power efficiency of up to 94% and include a standard C-14 power inlet connector.

HPE 800W Flex Slot -48VDC Hot Plug Low Halogen Power Supply Kit 865434-B21

Notes: Flex Slot -48VDC power supplies support power efficiency of up to 94%.

HPE 800W Flex Slot Universal Hot Plug Low Halogen Power Supply Kit 865428-B21

HPE 1600W Flex Slot Platinum Hot Plug Low Halogen Power Supply Kit P38997-B21

HPE 1600W Flex Slot -48VDC Hot Plug Power Supply Kit P17023-B21

Notes: Flex Slot -48VDC power supplies support power efficiency of up to 94%

HPE 1600W -48VDC Power Cable Lug Kit P36877-B21

Notes:

- P36877-B21 is to be used with HPE 1600W Flex Slot -48VDC Hot Plug Power Supply Kit
- Only one power cable lug kit needs to be selected with the power supply

Notes:

- Flex Slot universal power supplies support power efficiency of up to 94% and support both 277VAC/380VDC power inputs.
- Flex Slot Platinum Plus power supplies support power efficiency of up to 94% and include a C-14 power inlet connector that can support HPE Power Discovery Services (blue connector).
- Prior to making a power supply selection it is highly recommended that the HPE Power Advisor is run to determine the right size power supply for your server configuration. The HPE Power Advisor is located at: <http://www.hpe.com/info/hppoweradvisor>.
- All power supplies in a server should match. Mixing Power Supplies is not supported.
- Option kits contain the specified power supply and a PDU IEC cable.
- 1600W power supplies only support high line voltage.
- HPE ProLiant servers ship with an IEC-IEC power cord used for rack mounting with Power Distribution Units (PDUs). Visit [HPE power cords](#) for a full list of optional HPE power cords.



Core Options

Riser Information									
Part number	Description	Riser position			Bus width (Gen4 lanes)			NVMe Direct Connect	
		Primary	Secondary	Tertiary	Top slot	Middle Slot	Bottom slot	Ports	Drive count
N/A	HPE DL345 Gen10 Plus x16/x16 Primary Riser	D	N	N	x16	x16	N	0	0
P38639-B21	HPE DL345 Gen10 Plus 2x8 Sec Riser Kit	N	O	N	x8	x8	N	0	0
P38641-B21	HPE DL345 Gen10 Plus x16 Sec Riser Kit	N	O	N	x16	N	N	0	0
P38637-B21	HPE DL345 Gen10 Plus x16 Slim Prim Riser Kit	O	N	N	N	x16	N	2	4
P38643-B21	HPE DL345 Gen10 Plus 2x8 Slim Sec Riser Kit	N	O	N	N	N	N	2	4

Notes: Y = supported; D = default on Chassis; O = optional; N = not supported or slot/connector not present.



Additional Options

Some options may not be integrated at the factory. To ensure only valid configurations are ordered, Hewlett Packard Enterprise recommends the use of an HPE approved configurator. Contact your local sales representative for additional information.

Embedded Management

HPE iLO Advanced

HPE iLO Advanced Electronic License with 1yr Support on iLO Licensed Features	E6U59ABE
HPE iLO Advanced 1-server License with 1yr Support on iLO Licensed Features	512485-B21
HPE iLO Advanced Flexible Quantity License with 1yr Support on iLO Licensed Features	512486-B21
HPE iLO Advanced AKA Tracking License with 1yr Support on iLO Licensed Features	512487-B21
HPE iLO Advanced Electronic License with 3yr Support on iLO Licensed Features	E6U64ABE
HPE iLO Advanced 1-server License with 3yr Support on iLO Licensed Features	BD505A
HPE iLO Advanced Flexible Quantity License with 3yr Support on iLO Licensed Features	BD506A
HPE iLO Advanced AKA Tracking License with 3yr Support on iLO Licensed Features	BD507A
HPE iLO Common Password FIO Setting	P08040-B21

Software as a Service Management

HPE GreenLake for Compute Ops Management

HPE GreenLake for Compute Ops Management Enhanced 3-year Upfront ProLiant SaaS	R7A11AAE
--	----------

Additional Options

HPE GreenLake for Compute Ops Management Enhanced 1-year Upfront ProLiant SaaS	R7A10AAE
HPE GreenLake for Compute Ops Management Enhanced 5-year Upfront ProLiant SaaS	R7A12AAE

Notes: For customers purchasing HPE GreenLake for Compute Ops Management, without a hardware purchase or a BTO purchase, use this base SKU within ASQ order:

HPE GreenLake for Compute Ops Management Base SaaS	R6Z73AAE
--	----------

HPE Converged Infrastructure Management Software

HPE OneView Standard 1yr 9x5 Support Flexible Quantity E-RTU	K6F98AAE
HPE OneView including 3yr 24x7 Support Physical 1-server LTU	E5Y34A
HPE OneView including 3yr 24x7 Support Track 1-server LTU	E5Y36A
HPE OneView including 3yr 24x7 Support Flexible Quantity E-LTU	E5Y35AAE
HPE OneView Upgrade from Insight Management 3yr 24x7 Support 1-server LTU	F6Q91A
HPE OneView w/o iLO including 3yr 24x7 Support 1-server LTU	P8B24A
HPE OneView w/o iLO including 3yr 24x7 Support Track 1-server LTU	P8B25A
HPE OneView w/o iLO including 3yr 24x7 Support 1-server FIO LTU	P8B31A
HPE OneView for ProLiant DL Server including 3yr 24x7 Support FIO Bundle Physical 1-server LTU	E5Y43A
HPE OneView for ProLiant DL Server including 3yr 24x7 Support Bundle Track 1-server LTU	E5Y44A
HPE OneView Upgrade from Insight Management including 3yr 24x7 Support Flexible Quantity E-LTU	E5Y45AAE
HPE OneView w/o iLO including 3yr 24x7 Support Flexible Quantity E-LTU	P8B26AAE

Notes: Licenses ship without media. The HPE OneView Media Kit can be ordered separately, or can be [downloaded](#).

HPE Security

HPE Server Platform LDevID FIO Setting	P49803-B21
--	------------

Notes:

- Directs HPE manufacturing site to create, digitally sign and store a platform certificate on the server
- Requires HPE Trusted Platform Module (TPM)



Additional Options

- Locally Significant Device Identifier (LDevID) certificates are part of a Zero Trust Architecture. This SKU instructs factory to provision LDevID on HPE iLO

HPE Server Identity LDevID FIO Setting P49814-B21

Notes: Locally Significant Device Identifier (LDevID) certificates are part of a Zero Trust Architecture. This SKU instructs factory to only provision LDevID on HPE iLO

HPE Gen10 2U Bezel Kit 867809-B21

HPE Bezel Lock Kit 875519-B21

HPE Gen10 Plus Chassis Intrusion Detection Kit P14604-B21

HPE Gen10 TPM 1.2 FIO Setting 872108-B21

HPE Trusted Platform Module 2.0 Gen10 Plus Black Rivets Kit P13771-B21

Notes:

- This is TPM 2.0 for Gen10 plus
- If this option is selected into a system operating in the Legacy BIOS mode (758959-B21), it cannot operate at the TPM 2.0 setting. It must operate at the TPM 1.2 setting. Therefore, if this option is ordered with the Legacy BIOS mode (758959-B21), then TPM 1.2 FIO (872108-B21) should also be ordered.
- This provides a physical connection from the chassis board and hood and detects any physical intrusion into the chassis, providing security during the entire supply chain process of shipping, receiving, distribution, and operation

HPE Boot Controllers

HPE NS204i-p x2 Lanes NVMe PCIe3 x8 OS Boot Device P12965-B21

Notes: Requires UEFI, not supported on Legacy Mode.

HPE Smart Storage SR100i SR Gen10 Plus SW RAID

HPE SR100i Gen10 Plus FIO Software RAID P28417-B21

Notes: Requires UEFI, not supported on Legacy Mode.

HPE Smart Array Controllers

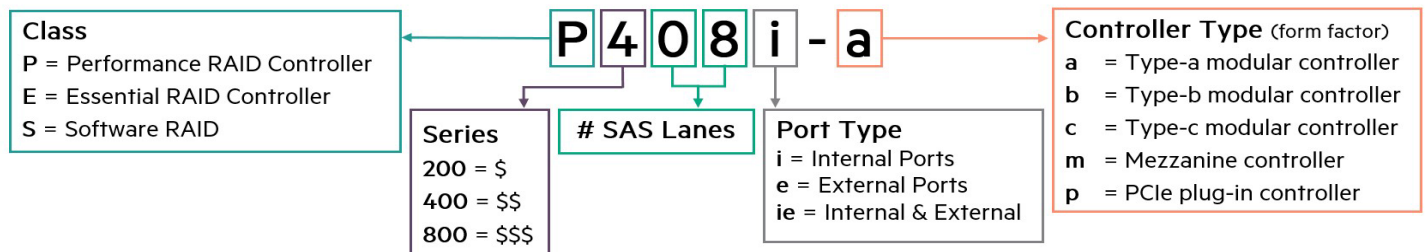

Additional Options

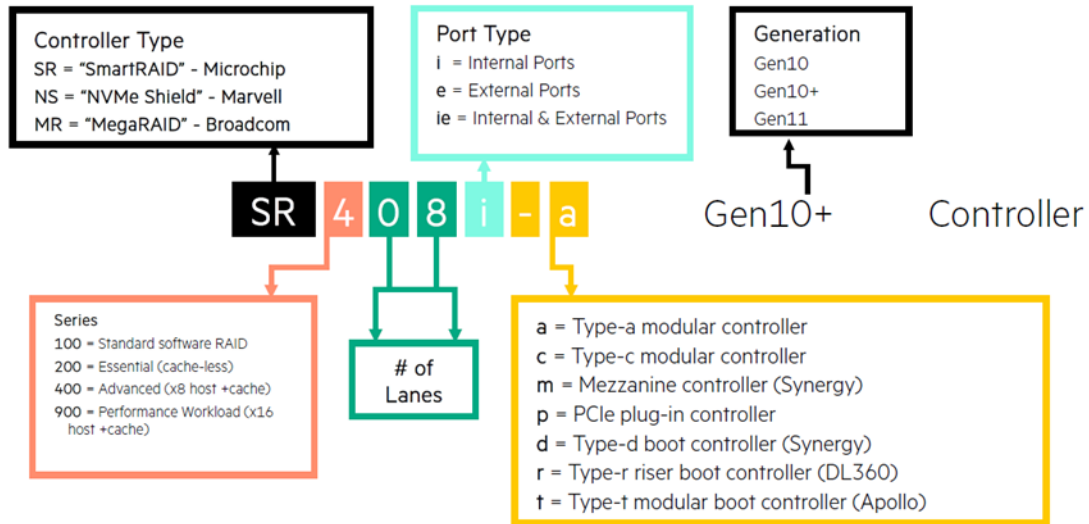

HPE 96W Smart Storage Battery (up to 20 Devices) with 145mm Cable Kit

Notes: All performance RAID controllers are supported by the HPE Smart Storage Battery (P01366-B21), which supports multiple devices and is sold separately.

HPE Smart Array P816i-a SR Gen10 (16 Internal Lanes/4GB Cache/SmartCache) 12G SAS Modular Controller 804338-B21

Notes:

- Does not occupy a PCIe expansion slot and includes SmartCache license.
- The P816i-a cable ships in the 12LFF chassis only.

HPE Smart Array P408i-a SR Gen10 (8 Internal Lanes/2GB Cache) 12G SAS Modular Controller 804331-B21

Notes: Does not occupy a PCIe expansion slot.

HPE Smart Array P408i-p SR Gen10 (8 Internal Lanes/2GB Cache) 12G SAS PCIe Plug-in Controller 830824-B21

HPE Smart Array P408e-p SR Gen10 (8 External Lanes/4GB Cache) 12G SAS PCIe Plug-in Controller 804405-B21

Essential RAID Controllers

HPE Smart Array E208i-p SR Gen10 (8 Internal Lanes/No Cache) 12G SAS PCIe Plug-in Controller 804394-B21

HPE Smart Array E208e-p SR Gen10 (8 External Lanes/No Cache) 12G SAS PCIe Plug-in Controller 804398-B21

HPE Smart Array E208i-a SR Gen10 (8 Internal Lanes/No Cache) 12G SAS Modular Controller 804326-B21

Notes: Does not occupy a PCIe expansion slot.

Tri-mode RAID Controllers

Microchip SmartRAID SR932i-p x32 Lanes 8GB Wide Cache NVMe/SAS 24G Controller for HPE Gen10 Plus P04220-B21

Notes:

- This card should only be supported on a x16 electrical PCIe slot. For PCIe slot information, refer to the "Expansion Slots" section in this document
- This controller can support below Drive Cages
 - o 8SFF NVME x1 U.3 drive cage (P27194-B21)
 - o 8SFF NVME x4 U.3 drive cage (P26931-B21)
 - o 8SFF NVME x4 U.2 drive cage (P26932-B21)

Microchip SmartRAID SR416i-a x16 Lanes 4GB Cache NVMe/SAS 24G Controller for HPE Gen10 Plus P12688-B21

Broadcom MegaRAID MR416i-p x16 Lanes 4GB Cache NVMe/SAS 12G Controller for HPE Gen10 Plus P06367-B21

Broadcom MegaRAID MR416i-a x16 Lanes 4GB Cache NVMe/SAS 12G Controller for HPE Gen10 Plus P26279-B21

Broadcom MegaRAID MR216i-p x16 Lanes without Cache NVMe/SAS 12G Controller for HPE Gen10 Plus P26324-B21



Additional Options

Broadcom MegaRAID MR216i-a x16 Lanes without Cache NVMe/SAS 12G Controller for HPE Gen10 Plus P26325-B21

Notes: If one of these controllers P816i-a/ P408e-p/P408i-a/P408i-p/SR932i-p/MR416i-p/MR416i-a/SR416i-a is selected then either 96W Smart Storage Battery (P01366-B21) or Smart Hybrid Capacitor (P02377-B21) must be selected. Max = 1 Storage Battery/ Capacitors per server.

HPE Cable Options

HPE ProLiant DL345 Gen10 Plus Tri-Mode Premium Cable Kit P38657-B21

Notes:

- If one q'ty of 8SFF NVMe x4 U.3 drive cage is selected, then this cable kit must be selected
- If one or two q'ty of 8SFF NVMe x4 U.2 drive cage is selected, then this cable kit must be selected

HPE ProLiant DL345 Gen10 Plus 8NVMe Direct Attach FIO Cable Kit P38659-B21

Notes:

- If one q'ty of 8SFF NVMe x4 U.3 drive cage is selected and NVMe drives are direct attach, then this cable kit must be selected
- If one q'ty of 8SFF NVMe x4 U.2 drive cage is selected and NVMe drives are direct attach, then this cable kit must be selected

HPE ProLiant DL345 Gen10 Plus 16NVMe Direct Attach FIO Cable Kit P38660-B21

Notes:

- If two q'ty of 8SFF NVMe x4 U.3 drive cage is selected and NVMe drives are direct attach, then this cable kit must be selected
- If two q'ty of 8SFF NVMe x4 U.2 drive cage is selected and NVMe drives are direct attach, then this cable kit must be selected

HPE ProLiant DL345 Gen10 Plus 24NVMe Direct Attach FIO Cable Kit P38661-B21

Notes: If three q'ty of 8SFF NVMe x4 U.3 or 8SFF NVMe x4 U.2 are selected and NVMe drives are direct attach, then this cable kit must be selected

HPE ProLiant DL345 Gen10 Plus Smart Storage Battery Cable Kit P38630-B21

Notes: Max=3, this option can be selected only with either 96W Smart Storage Battery or Smart Hybrid Capacitor

HPE ProLiant DL345 Gen10 Plus 8SFF SATA Box 3 Cable Kit P39720-B21

Notes: If 8SFF CTO chassis is selected and drives are direct attach, then this cable kit must be selected

HPE ProLiant DL345 Gen10 Plus 8SFF SAS/SATA Box 3 Cable Kit P39722-B21

Notes: If 8SFF CTO chassis is selected and PCIe smart array controller is in use, then this cable kit must be selected

HPE ProLiant DL345 Gen10 Plus 8SFF AROC x8 SAS/SATA Box 3 Cable Kit P39723-B21

Notes: If 8SFF CTO chassis is selected and AROC smart array controller is in use, then this cable kit must be selected

HPE ProLiant DL345 Gen10 Plus 8SFF AROC x16 SAS/SATA Box 1-3 Cable Kit P39726-B21

Notes: If 8SFF CTO chassis and 8SFF Bay1/2 drive cage are selected with an AROC smart array controller in use, then this cable kit must be selected

HPE ProLiant DL345 Gen10 Plus 8LFF Embedded SATA Cable Kit P39728-B21

Notes: If 8LFF CTO chassis is selected and drives are direct attach, then this cable kit must be selected

HPE ProLiant DL345 Gen10 Plus 8LFF Smart Array SAS/SATA Cable Kit P39730-B21

Notes: If 8LFF CTO chassis is selected and AROC smart array controller is in use, then this cable kit must be selected

HPE ProLiant DL345 Gen10 Plus 2SFF SAS/SATA Rear Cable Kit P40652-B21

Notes: If 2SFF U.3 drive cage is selected and SAS/SATA drives are selected with it, then this cable kit must be selected



Additional Options

HPE ProLiant DL345 Gen10 Plus 2SFF NVMe Cable Kit	P40654-B21
Notes: If 2SFF U.3 drive cage is selected and NVMe U.3 drives are selected with it, then this cable kit must be selected	
HPE DL325 Gen10 Plus 8SFF Optical Disk Drive SATA/M.2 Enablement Kit	P20423-B21
Notes: This cable kit is required when HPE Universal SATA AIC HHHL M.2 SSD Kit (878783-B21) is selected	
HPE ProLiant DL325 Gen10 Plus v2/DL345 Gen10 Plus OCP Upgrade Cable Kit	P39732-B21
Notes: OCP Upgrade Kit (P39732-B21) must be selected If any of the below option is selected:	
– HPE 10/25GbE 2p SFP28 MCX562A OCP3 Adptr (P10112-B21)	
– HPE IB HDR/EN 200Gb 2p QSFP56 OCP3 Adptr (P31348-B21)	
– HPE IB HDR/EN 200Gb 1p QSFP56 OCP3 Adptr (P31323-B21)	
– INT E810 100GbE 2p QSFP28 OCP3 Adptr (P22767-B21)	
HPE ProLiant DL300 Gen10 Plus 2U x2 Tri-Mode Cable Kit	P36203-B21
Notes: This cable provides x1 or x2 connection to configurations with either one or two 8SFF NVMe x4 U.3 drive cage(s) selected	
HPE ProLiant DL38x LFF SAS/SATA Tri-Mode Cable Kit	P58900-B21
Notes: If 8SFF Model-X and 8SFF UBM2/TM drive cage (P55516-B21) are in the order, then this cable kit must be selected.	
HPE ProLiant DL38x Gen10 Plus 2SFF Rear Tri-Mode Cable Kit	P55471-B21
Notes: this cable kit can be selected with 24SFF Model-X only	
HPE Smart Storage Hybrid Capacitor with 145mm Cable Kit	P02377-B21
Notes: 1 of either Smart Storage Battery (P01366-B21) or Smart Hybrid Capacitor (P02377-B21) can be selected in the order	
HPE 96W Smart Storage Lithium-ion Battery with 145mm Cable Kit	P01366-B21
Notes: 1 of either Smart Storage Battery (P01366-B21) or Smart Hybrid Capacitor (P02377-B21) can be selected in the order	
HPE DL3XX Gen10 Rear Serial Cable and Enablement Kit	873770-B21

HPE Disk-Based Backup

HPE RDX External Docking Station	C8S07B
----------------------------------	--------

HPE Racks

- Please see the [HPE Advanced Series Racks QuickSpecs](#) for information on additional racks options and rack specifications.
- Please see the [HPE Enterprise Series Racks QuickSpecs](#) for information on additional racks options and rack specifications.
- Please see the [HPE Standard Series Racks QuickSpecs](#) for information on additional racks options and rack specifications.

HPE Power Distribution Units (PDUs)

- Please see the [HPE Basic Power Distribution Units \(PDU\) QuickSpecs](#) for information on these products and their specifications.
- Please see the [HPE Metered Power Distribution Units \(PDU\) QuickSpecs](#) for information on these products and their specifications.
- Please see the [HPE Intelligent Power Distribution Unit \(PDU\) QuickSpecs](#) for information on these products and their specifications.
- Please see the [HPE Metered and Switched Power Distribution Units \(PDU\) QuickSpecs](#) for information on these products and their specifications.



Additional Options

HPE Uninterruptible Power Systems (UPS)

- To learn more, please visit the [HPE Uninterruptible Power Systems \(UPS\) web page](#).
- Please see the [HPE DirectFlow Three Phase Uninterruptible Power System QuickSpecs](#) for information on these products and their specifications.
- Please see the [HPE Line Interactive Single Phase UPS QuickSpecs](#) for information on these products and their specifications.

HPE Rack Options

- Please see the [HPE KVM Switches web page](#) for information on these products and their specifications.

Rail Kits

Notes:

- Easy Install rail kits contain telescoping rails which allow for in-rack serviceability.
- To assist in the installation of the server into the rack an optional installation tool is available by contacting your local services representative (695539-001).
- Hewlett Packard Enterprise recommends that a minimum of two people are required for all Rack Server installations. Please refer to your installation instructions for proper tools and number of people to use for any installation.
- CTO Models do not ship with rail kits, they need to be ordered separately

HPE DL38X Gen10 Plus 2U SFF Easy Install Rail Kit	P22018-B21
Notes: Supported on SFF Model only	
HPE DL38X Gen10 Plus 2U LFF Easy Install Rail Kit	P22019-B21
Notes: Supported on LFF Model only	
HPE DL38X Gen10 Plus 2U Cable Management Arm for Rail Kit	P22020-B21

HPE USB and SD Options

HPE Enterprise Mainstream Flash Media Kits for Memory Cards

HPE 32GB microSD RAID 1 USB Boot Drive	P21868-B21
--	------------

Notes: In vSphere 7.0, VMware made changes that impact the use of an SD Card/USB media as a standalone boot device and will be removing support for them after version 7.x.

SD Card/USB media can still be used as a standalone boot option through all 7.x releases via published Customer Advisory [Usage of SD Card/USB Devices As Standalone Boot Devices Has Changed Due to System Storage Changes For VMware ESXi 7.0 \(Or Later\)](#).

For any major release beyond VMware ESXi 7.x, VMware will require M.2 or another local persistent device as the standalone boot option.

HPE Support Services

Installation & Startup Services

HPE Install ProLiant DL38x(p) Service	U4554E
HPE Installation and Startup DL38x(p) Service	U4555E

Tech Care

HPE 3 Year Tech Care Essential ProLiant DL345 Gen10 Plus Service	HY5K1E
HPE 3 Year Tech Care Essential wDMR ProLiant DL345 Gen10 Plus Service	HY5K2E
HPE 5 Year Tech Care Essential ProLiant DL345 Gen10 Plus Service	HY5M5E
HPE 5 Year Tech Care Essential wDMR ProLiant DL345 Gen10 Plus Service	HY5M6E

Notes: For a full listing of Support Services available for this server, please visit <http://www.hpe.com/services>.



Memory

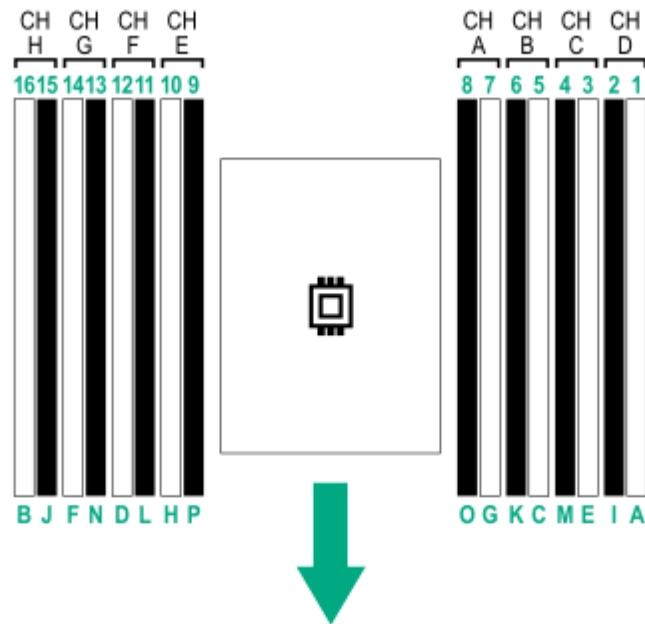

General Memory Population Rules and Guidelines:

- Install DIMMs only if the corresponding processor is installed.
- To maximize performance, it is recommended to balance the total memory capacity between all installed processors.
- White DIMM slots denote the first slot to be populated in a channel.
- Mixing of DIMM types (RDIMM, and LRDIMM) is not supported.
- The maximum memory speed is a function of the memory type, memory configuration, and processor model.
- The maximum memory capacity is a function of the number of DIMM slots on the platform, the largest DIMM capacity qualified on the platform, the number and model of installed processors qualified on the platform.
- For details on the HPE Server Memory Options Population Rules, visit: <https://www.hpe.com/docs/amd-population-rules-Gen10plus>
- To realize the performance memory capabilities listed in this document, HPE DDR4 Smart Memory is required. For additional information, please see the: [HPE DDR4 Smart Memory QuickSpecs](#)
- For details on the HPE Server Memory speed, visit: <http://www.hpe.com/docs/amd-speed-tables>



Storage

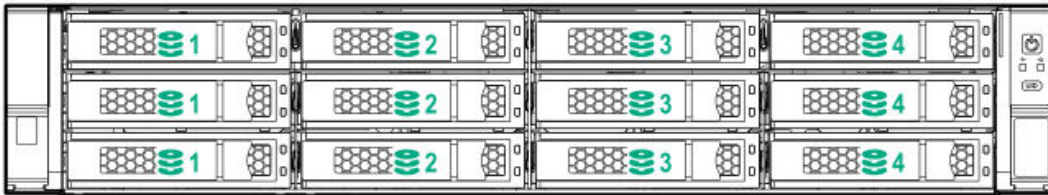

12 LFF Front Panel

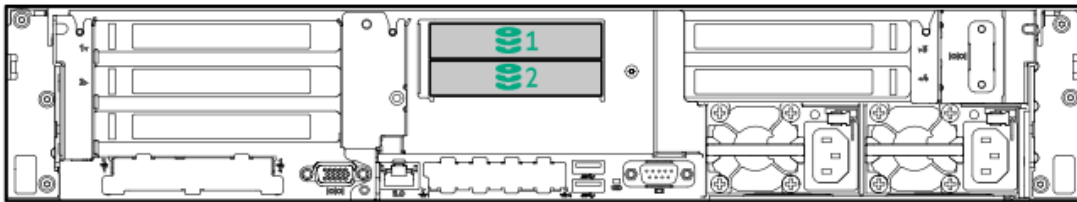

Rear Panel + rear 2 SFF drives



24 SFF Front Panel



Technical Specifications

System Unit

Dimensions

- **SFF Drives**
8.75 x 44.54 x 71.1 cm 3.44 x 17.54 x 28 in
- **LFF Drives:**
8.75 x 44.54 x 74.9 cm 3.44 x 17.54 x 29.5 in

Weight (approximate)

- **SFF configuration**
 - **Minimum:** 16.33 kg / 36.00 lbs with 2 hard drives
(8 SFF chassis with 6x HDD blanks, 2x Drive Bay blanks, 1x processor including standard heatsink, 1x DIMM , 1x power supply (plus blank), 1x Smart Array, 1x Riser installed, cables for the above)
 - **Maximum:** 23.1 kg / 50.93 lbs with 24 hard drives
(24 SFF hard drives, 1x processor including standard heatsink, 16x DIMMs, 2x power supplies, 1x Smart Array, 2x Risers installed, cables for the above)
- **LFF Configuration**
 - **Minimum** 22.1 kg / 48.72 lbs with 2 hard drives
(8 LFF chassis with 6x HDD blanks, 4x LFF HDD Bay blanks, 1x processor including standard heatsink, 1x DIMM, 1x power supply (plus blank), 1x Smart Array, 1x Riser installed, cables for the above)
 - **Maximum** 26.12 kg / 57.58 lbs with 12 hard drives
(12 LFF hard drives(no rear drives), 1x processor including standard heatsink, 16x DIMMs, 2x power supplies, 1x Smart Array, 2x Risers installed, cables for the above)

Input Requirements (per power supply)

Rated Line Voltage

- 100 to 120 VAC
- 200 to 240 VAC

BTU Rating

Maximum

- For 1600W Power Supply: 5918 BTU/hr (at 200 VAC), 5884 BTU/hr (at 240 VAC) for China
 - For 800W Power Supply: 3207 BTU/hr (at 100 VAC), 3071 BTU/hr (at 200 VAC), 3112 BTU/hr (at 240 VAC) for China Only
 - For 500W Power Supply: 1979 BTU/hr (at 100 VAC), 1911 BTU/hr (at 200 VAC), 1965 BTU/hr (at 240 VAC) for China Only
-



Technical Specifications

Power Supply Output (per power supply)

Rated Steady-State Power

- For 1600W Power Supply: 1600W (at 240 VAC), 1600W (at 240 VAC)
- For 800W Power Supply: 800W (at 100 VAC), 800W (at 240 VAC), 800W (at 240 VAC) input for China only
- For 500W Power Supply: 500W (at 100 VAC), 500W (at 240 VAC), 500W (at 240 VAC) input for China only

Maximum Peak Power

- For 1600W Power Supply: 1600W (at 200 to 240 1VAC), 1600W (at 240 VAC) input for China only
- For 800W Power Supply: 800W (at 100 to 127 VAC), 800W (at 200 to 240 1VAC), 800W (at 240 VAC) input for China only
- For 500W Power Supply: 500W (at 100 to 127 VAC), 500W (at 200 to 240 VAC), 500W (at 240 VAC) input for China only

System Inlet Temperature

- **Standard Operating Temperature**

10° to 35°C (50° to 95°F) at sea level with an altitude derating of 1.0°C per every 305 m (1.8°F per every 1000 ft) above sea level to a maximum of 3050 m (10,000 ft), no direct sustained sunlight. Maximum rate of change is 20°C/hr (36°F/hr). The upper limit and rate of change may be limited by the type and number of options installed.

System performance during standard operating support may be reduced if operating with a fan fault or above 30°C (86°F).

- **Extended Ambient Operating Temperature**

For approved hardware configurations, the supported system inlet range is extended to be: 5° to 10°C (41° to 50°F) and 35° to 40°C (95° to 104°F) at sea level with an altitude derating of 1.0°C per every 175 m (1.8°F per every 574 ft) above 900 m (2953 ft) to a maximum of 3050 m (10,000 ft). The approved hardware configurations for this system are listed at the URL: <http://www.hpe.com/servers/ashrae>

For approved hardware configurations, the supported system inlet range is extended to be: 40° to 45°C (104° to 113°F) at sea level with an altitude derating of 1.0°C per every 125 m (1.8°F per every 410 ft) above 900 m (2953 ft) to a maximum of 3050 m (10,000 ft). The approved hardware configurations for this system are listed at the

URL: <http://www.hpe.com/servers/ashrae>

System performance may be reduced if operating in the extended ambient operating range or with a fan fault.

- **Non-operating**

-30° to 60°C (-22° to 140°F). Maximum rate of change is 20°C/hr (36°F/hr).

Relative Humidity

- **Operating**

8% to 90% - Relative humidity (Rh), 28°C maximum wet bulb temperature, non-condensing.

- **Non-operating** (non-condensing)

5 to 95% relative humidity (Rh), 38.7°C (101.7°F) maximum wet bulb temperature, non-condensing.

Altitude

- **Operating**

3050 m (10,000 ft). This value may be limited by the type and number of options installed. Maximum allowable altitude change rate is 457 m/min (1500 ft/min).

- **Non-operating**

9144 m (30,000 ft). Maximum allowable altitude change rate is 457 m/min (1500 ft/min).

RTC Accuracy

- 50 ppm



Technical Specifications

Emissions Classification (EMC) – Regulatory Information

To view the regulatory information for your product, view the Safety and Compliance Information for Server, Storage, Power, Networking, and Rack Products, available at the Hewlett Packard Enterprise Support Center:

<http://www.hpe.com/support/Safety-Compliance-EnterpriseProducts>

HPE Smart Array

For latest information on **HPE Smart Array Gen10 Controllers for HPE ProLiant DL, ML and Apollo Servers** please refer to their QuickSpecs. (E208i-a,E208i-p,E208e-p,P408i-a,P408i-p,P408e-p,P816i-a)

Acoustic Noise

Listed are the declared A-Weighted sound power levels (LWAd) and declared average bystander position A-Weighted sound pressure levels (LpAm) when the product is operating in a 23°C ambient environment. Noise emissions were measured in accordance with ISO 7779 (ECMA 74) and declared in accordance with ISO 9296 (ECMA 109). The listed sound levels apply to standard shipping configurations. Additional options may result in increased sound levels. Please have your HPE representative provide information from the HPE EMESC website for further technical details regarding the configurations listed below.

Idle	
LWAd	4.9 B Entry 5.0 B Base
LpAm	31 dBA Entry 32 dBA Base
Operating	
LWAd	5.1 B Entry 5.3 B Base
LpAm	34 dBA Entry 35 dBA Base

Notes:

- Acoustics levels presented here are generated by the test configuration only. Acoustics levels will vary depending on system configuration. Values are subject to change without notification and are for reference only.
- Product conformance to cited product specifications is based on sample (type) testing, evaluation, or assessment. This product or family of products is eligible to bear the appropriate compliance logos and statements.
- The Listed sound levels apply to standard shipping configurations. Additional options may result in increased sound levels.

Environment-friendly Products and Approach - End-of-life Management and Recycling

Hewlett Packard Enterprise offers **end-of-life product return, trade-in, and recycling programs** in many geographic areas, for our products. Products returned to Hewlett Packard Enterprise will be recycled, recovered or disposed of in a responsible manner.

The EU WEEE directive (2002/95/EC) requires manufacturers to provide treatment information for each product type for use by treatment facilities. This information (product disassembly instructions) is posted on the Hewlett Packard Enterprise web site. These instructions may be used by recyclers and other WEEE treatment facilities as well as Hewlett Packard Enterprise OEM customers who integrate and re-sell Hewlett Packard Enterprise equipment.



Summary of Changes

Date	Version History	Action	Description of Change
11-Sep-2023	Version 22	Changed	Standard Features, Configuration Information, Core Options, and Additional Options sections were updated
05-Jun-2023	Version 21	Changed	Core Options Section was updated.
01-May-2023	Version 20	Changed	Optional Features and Additional Options sections were updated.
17-Apr-2023	Version 19	Changed	Overview and Core Options sections were updated.
10-Jan-2023	Version 18	Changed	Standard Features and Core Options sections were updated. Obsolete SKUs were removed.
05-Dec-2022	Version 17	Changed	Core Options section was updated.
07-Nov-2022	Version 16	Changed	Standard Features, Optional Features, Additional Options and Core Options sections were updated. Obsolete SKUs were removed.
19-Sep-2022	Version 15	Changed	Standard Features and Core Options sections were updated. Obsolete SKUs were removed.
01-Aug-2022	Version 14	Changed	Configuration Information and Core Options sections were updated. Obsolete SKUs were removed.
05-Jul-2022	Version 13	Changed	Standard Features, Core Options and Additional Options sections were updated. Obsolete SKUs were removed.
06-Jun-2022	Version 12	Changed	Core Options section was updated.
02-May-2022	Version 11	Changed	Core Options section was updated. Obsolete SKUs were removed.
07-Mar-2022	Version 10	Changed	Configuration Information section was updated.
07-Feb-2022	Version 9	Changed	Standard Features section was updated. Obsolete SKUs were removed.
06-Dec-2021	Version 8	Changed	Configuration Information, Core Options and Additional Options sections were updated. Obsolete SKUs were removed.
01-Nov-2021	Version 7	Changed	Standard Features, Core Options, Service and Support and Additional Options sections were updated.
07-Sep-2021	Version 6	Changed	Overview and Core Options sections were updated. Obsolete SKUs were removed.
02-Aug-2021	Version 5	Changed	Configuration Information and Core Options sections were updated.
06-Jul-2021	Version 4	Changed	Standard Features and Core Options sections were updated. Obsolete SKUs were removed.
07-Jun-2021	Version 3	Changed	Standard Features, Pre-configured Models, Configuration Information and Core Options sections were updated.
10-May-2021	Version 2	Changed	Standard Features, Configuration Information and Core Options sections were updated.
19-Apr-2021	Version 1	New	New QuickSpecs.



Copyright

**Make the right purchase decision.
Contact our presales specialists.**



© Copyright 2023 Hewlett Packard Enterprise Development LP. The information contained herein is subject to change without notice. The only warranties for Hewlett Packard Enterprise products and services are set forth in the express warranty statements accompanying such products and services. Nothing herein should be construed as constituting an additional warranty. Hewlett Packard Enterprise shall not be liable for technical or editorial errors or omissions contained herein.

AMD® and EPYC® are registered trademarks of Advanced Micro Devices Corporation in the U.S. and other countries.

Microsoft®, Windows®, and Windows Server® are U.S. registered trademarks of the Microsoft group of companies.

For hard drives, 1GB = 1 billion bytes. Actual formatted capacity is less

a50002557enw - 16712 - Worldwide - V22 - 11-September-2023